

ON-LINE DETERMINATION OF OPTIMAL HYSTERESIS BAND AMPLITUDES IN DIRECT TORQUE CONTROL OF INDUCTION MOTOR DRIVES

S. Vaez-Zadeh and G.H. Mazarei

Advanced Motion Systems Research Lab, Department of Electrical and Computer Engineering
University of Tehran, North Kargar Ave., P.O. Box:14395/515, Tehran, Iran
Fax: +98-21-8778690, vaezs@ut.ac.ir

(Received: September 17, 2000 – Accepted in Revised Form: October 3, 2002)

Abstract In conventional direct torque control (DTC) of induction machines, undesirable flux and torque ripples are produced. These occur since non of the selected inverter's voltage vectors are able to generate the exact voltage required to produce the desired changes in the electromagnetic torque and stator flux linkage in most of the switching instances. In addition, when direct torque control is implemented in a digital form these ripples will increase due to sampling and computation delays. In this paper, the influences of the amplitudes of flux and torque hysteresis bands and the sampling time of control program on the torque and flux ripples are investigated. A new method is then proposed for the determination and application of optimal hysteresis band amplitudes in DTC to reduce flux and torque ripples, and prevent the inverter switching frequency to exceed a desired limit. Extensive simulation results confirm the superiority of the DTC under the proposed method over the conventional DTC.

Key Words Induction Motors, Direct Torque Control, Hysteresis Bands

چکیده در کنترل مستقیم گشتاور در ماشین القایی به روش معمول، ضربان های ناخواسته شار و گشتاور تولید می شود؛ زیرا هیچ یک از بردارهای ولتاژ انتخابی اینورتر قادر به تولید بردار ولتاژ مورد نیاز برای ایجاد تغییرات مطلوب در گشتاور الکترومغناطیسی و شار پیوندی در بیشتر لحظات کلید زنی نیستند. همچنین هنگامی که کنترل مستقیم گشتاور به صورت کاملاً دیجیتالی پیاده سازی می شود، ضربان های مذکور به علت تاخیر ناشی از نمونه برداری و محاسبات افزایش می یابند. در این مقاله تأثیر دامنه باندهای هیستریزاس شار و گشتاور و زمان نمونه برداری برنامه کنترلی بر روی ضربان های گشتاور و شار بررسی می شود. سپس روش جدیدی برای تعیین و کاربرد دامنه بهینه باندهای هیستریزاس در کنترل مستقیم گشتاور پیشنهاد می شود تا ضربان های شار و گشتاور را کاهش دهد و از افزایش فرکانس کلیدزنی اینورتر از یک حد مطلوب پیشگیری کند. نتایج گسترده شبیه سازی، برتری کنترل مستقیم گشتاور تحت روش پیشنهادی را نسبت به روش معمول تأیید می کند.

1. INTRODUCTION

In Direct Torque Control of an induction machine the control strategy is based on the selection of appropriate stator voltage vectors in order to maintain the torque and the stator flux within their hysteresis bands. A small flux hysteresis band leads to a sinusoidal stator current waveform, while a small torque hysteresis band allows smooth torque and hence a silent drive to be established. On the other hand, small hysteresis bands usually result in higher switching frequencies thereby increasing the switching loss [1].

In the traditional analog implementation of

DTC, the switching frequency of inverter is not fixed and the amplitude of hysteresis band comparators limits the torque and flux errors. However, in digital implementation of DTC, the maximum switching frequency is fixed and the amplitude of Hysteresis band comparators does not limit the torque and flux errors. This is due to the delays of control system, which are applied by the control program execution time, the switching frequency limit of power electronic elements, the sluggish response of sensors, and the conversion time of A/Ds. Hence, if DTC core selects an appropriate stator voltage vector in one sampling period, the delay between the current and the next sampling

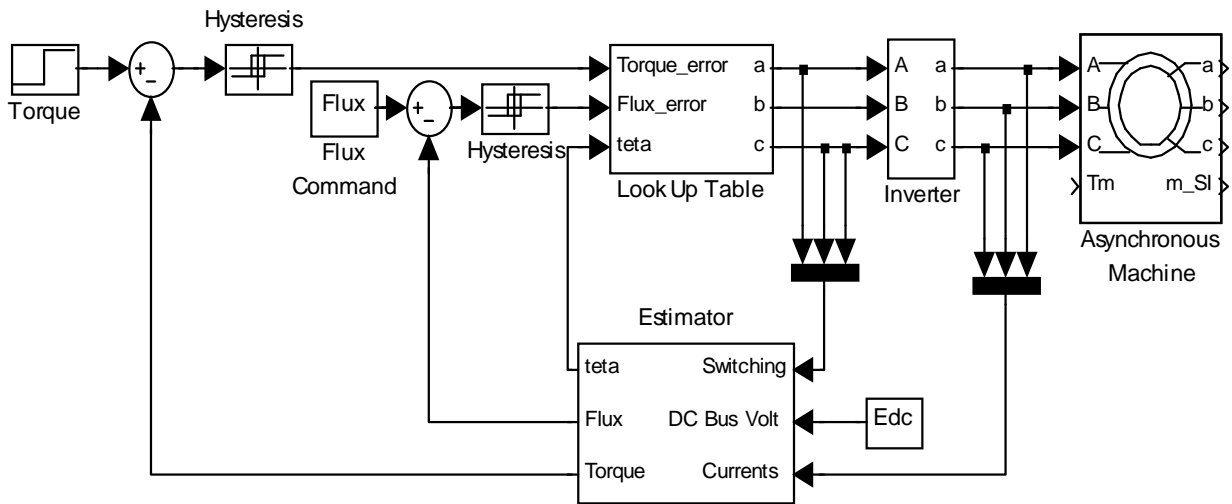

Figure 1. Block diagram of conventional DTC.

period may cause the errors increase and exceed the comparator bands. This has some adverse effects on the motor flux and torque ripples.

Casadei has investigated the effects of amplitudes of flux and torque comparators on the switching frequency of inverter, torque ripples, flux ripples, and stator current ripples through simulation [1]. However, the mathematical formulation has not been presented. In [2-5] new methods have been proposed for reducing the torque and flux ripples. Reference [2] describes a predictive control scheme of torque and flux errors based on the estimation of back emf, but a quadratic equation must be solved in each sampling period, which is very time consuming. Reference [3] has proposed a more simple predictive method for reducing torque ripples in low speed drives. A neuro fuzzy DTC scheme is also proposed which reduces the torque ripples of machine in low sampling periods [4]. In [5] a method is presented for reducing torque and flux ripples. This method introduces dither signal injection into the conventional system by superposing a high frequency and small amplitude triangular wave on the flux and torque errors respectively. But in this method the switching frequency increases resulting in high switching loss. Another way of reducing torque ripples is to change the inverter topology by using two GTO inverters connected in parallel [6]. However, this method is very costly. An alternative

method for reducing torque pulsation in DTC has been proposed based on a switching update rate, which is higher than the rated power device-switching rate, but does not over-switch the devices [7].

What is rather missing in the literature is a simple method for determining the proper value of the hysteresis bands to reduce the ripples. In this paper, the effects of hysteresis band amplitudes on the flux and torque ripples are analyzed. A novel method is then proposed for determining the optimal hysteresis bands to obtain minimum values of flux and torque ripples.

2. FUNDAMENTALS OF DTC

As is shown in Figure 1, DTC consists of three fundamental blocks i.e. motor model, torque and flux comparators and optimal switching logic. In the motor model block the magnitude of stator flux, its position and the electromagnetic torque are calculated. The purpose of hysteresis band comparators is updating the flux and torque status ($d\psi$ and dt_e). The comparison logic is as follows:

$$\begin{aligned}
 d\psi &= 1 && \text{if } |\bar{\Psi}_s| \leq |\bar{\Psi}_{sref}| - |\Delta\psi|, \\
 d\psi &= 0 && \text{if } |\bar{\Psi}_s| \geq |\bar{\Psi}_{sref}| + |\Delta\psi|
 \end{aligned}
 \tag{1}$$

For anticlockwise rotation

$$dt_e=1 \quad \text{if } |T_e| \leq |T_{\text{ref}}| - |\Delta T|, \quad (2)$$

$$dt_e=0 \quad \text{if } |T_e| \geq |T_{\text{ref}}|,$$

and for clockwise rotation

$$dt_e=-1 \quad \text{if } |T_e| \geq |T_{\text{ref}}| + |\Delta T|, \quad (3)$$

$$dt_e=0 \quad \text{if } |T_e| \leq T_{\text{ref}}.$$

The optimal switching logic selects the appropriate stator voltage based on a look up table.

3. FLUX AND TORQUE RIPPLES OF MACHINE

A. Flux Ripple From the induction motor equations and assuming a small stator resistance voltage drop, the stator flux vector variations are obtained as:

$$\Delta \bar{\Psi}_s \cong \bar{V}_s \cdot \Delta t, \quad (4)$$

where Δt is the time period during which the constant stator voltages vector \bar{V}_s , is applied to the stator. From (4) the magnitude of $\Delta \bar{\Psi}_{sr}$, the perpendicular component of $\Delta \bar{\Psi}_s$, can be described as:

$$\Delta \bar{\Psi}_{sr} = \bar{V}_s \cos \delta \Delta t, \quad (5)$$

where δ is the angle between stator flux vector, $\bar{\Psi}_s$, and \bar{V}_s . The minimum value of δ is 30 degrees. This can be obtained from the locations of flux vectors and the corresponding voltage vectors determined by the switching look up table. Hence the maximum value of $\Delta \bar{\Psi}_{sr}$ in each time interval is:

$$|\Delta \bar{\Psi}_{sr}| = \frac{\sqrt{3}}{2} \bar{V}_s \Delta t. \quad (6)$$

If the minimum switching time of inverter considered as T_{sw} , then the minimum flux ripple

will be:

$$|\Delta \bar{\Psi}_{s_{\min}}| = \frac{\sqrt{3}}{2} \bar{V}_s \cdot T_{sw} \quad (7)$$

If the hysteresis band amplitude of flux comparator is smaller than this value, the flux hysteresis band could not limit the flux ripples. In this condition, the flux ripples exceed the hysteresis band due to the delay between two consecutive switching. Also if the amplitude of flux hysteresis band is at a value greater than $|\Delta \bar{\Psi}_{s_{\min}}|$, the flux ripples exceed the hysteresis band due to the delay of sampling time. Hence a mathematical relationship for determining flux ripples in direct torque control can be achieved as:

$$\text{if } \Delta \psi \leq |\Delta \bar{\Psi}_{s_{\min}}|,$$

$$\Psi_{\text{ripple}} = \frac{\sqrt{3}}{2} \bar{V}_s \cdot T_{sw}, \quad (8.a)$$

$$\text{if } \Delta \psi > |\Delta \bar{\Psi}_{s_{\min}}|,$$

$$\Psi_{\text{ripple}} = \frac{\sqrt{3}}{2} \bar{V}_s \cdot T_s + \Delta \psi. \quad (8.b)$$

B. Torque Ripple For non-zero voltage vectors applied to the stator windings the changes in electromagnetic torque of machine is [3]:

$$\Delta T = \frac{P(\bar{\Psi}_s \times \bar{V}_s) - R_m T - P^2 \omega |\bar{\Psi}_s|^2}{L\sigma} \Delta t, \quad (9)$$

and for zero voltages applied to the machine the electromagnetic torque variations are given as:

$$\Delta T = \frac{R_m T + P^2 \omega |\bar{\Psi}_s|^2}{L\sigma} \Delta t. \quad (10)$$

In steady state conditions, the change in the electromagnetic torque during two consecutive switching instances is equal to:

$$\Delta T = \frac{P |\bar{\Psi}_s \times \bar{V}_s|}{L\sigma} \Delta t, \quad (11)$$

where $\Delta t = 2 T_{sw}$. Therefore, the torque ripple in a

switching period, which is equal to the minimum value of torque ripples, is:

$$\Delta T_{\text{ripplemin}} = \frac{P |\bar{\Psi}_s \times \bar{V}_s|}{2L\sigma} T_{\text{sw}} \quad (12)$$

However, when the hysteresis band amplitude is larger than the torque error of each switching period, then the torque ripples will exceed the hysteresis band due to the delays in digital control system. But the difference is not more than the torque ripple in one sampling period. Hence, the torque ripples can be expressed as:

if $\Delta T \leq \Delta T_{\text{ripplemin}}$,

$$T_{\text{ripple}} = \frac{P |\bar{\Psi}_s \times \bar{V}_s|}{2L\sigma} T_{\text{sw}}, \quad (13.a)$$

and if $\Delta T > \Delta T_{\text{ripplemin}}$,

$$T_{\text{ripple}} = \frac{P |\bar{\Psi}_s \times \bar{V}_s|}{2L\sigma} T_s + \Delta T. \quad (13.b)$$

4. DETERMINATION OF OPTIMAL HYSTERESIS BAND AMPLITUDES

As explained above, choosing small values for hysteresis bands leads to high switching frequencies, while limiting the switching frequency causes the flux and torque errors exceed the allowable hysteresis bands as seen in Equations 8.a and 13.a, resulting in an inaccurate motor operation. On the other hand, high values of the hysteresis bands increase flux and torque ripples. Therefore, the optimal values of hysteresis bands should be determined in order to limit the frequency and to reduce the flux and torque ripples at the same time.

The optimal values of the flux and torque hysteresis bands can be obtained from Equations 8.b and 13.b respectively as:

$$\Delta \psi = \frac{\sqrt{3}}{2} \bar{V}_s \cdot T_{\text{sw}} - \frac{\sqrt{3}}{2} \bar{V}_s \cdot T_s, \quad (14)$$

$$\Delta T = \frac{P |\bar{\Psi}_s \times \bar{V}_s|}{2L\sigma} T_{\text{sw}} - \frac{P |\bar{\Psi}_s \times \bar{V}_s|}{2L\sigma} T_s. \quad (15)$$

It is seen from Equations 14 and 15 that the optimal hysteresis band values depend on the stator voltage vector, and therefore on the DC link voltage of the inverter. The bands also depend on the stator flux vector, the switching frequency limit and the sampling time as seen in Equations 14 and 15. Therefore, constant flux and torque hysteresis bands cannot provide minimum flux and torque ripples since the above mentioned quantities, especially the flux vector, may vary during the machine operation as the load and the commanded signals change. In fact, Equations 14 and 15 propose changing values of the hysteresis bands for the achievement of minimum flux and torque ripples.

Based on Equations 14 and 15 a new method for the implementation of DTC is proposed. In this method an extra block, i.e. the hysteresis band estimator, is added to the DTC core to provide the required changing hysteresis bands according to Equations 14 and 15 as seen in Figure 2. The inputs to this block are the switching frequency limit, the dc link voltage, the flux amplitude and the sampling time. The frequency limit is set by the user taking into account the maximum switching frequency allowed for the power electronic devices of the inverter, and any other criterion related to the frequency like the switching losses. The outputs of the block are the optimal values of the flux and torque hysteresis bands, which are used as the inputs to the flux and torque comparators as seen in Figure 2. In this method, the amplitude of hysteresis bands are changed adaptively to obtain the minimum values of flux and torque ripples with a limited switching frequency.

5. PERFORMANCE EVALUATION

In this section the performance of an induction motor is examined under both the conventional and the proposed DTC methods by using MATLAB Simulink. The simulation results are compared and the superior motor performance under the proposed method is confirmed. The motor drive system parameters are shown in the Appendix.

A. The Conventional DTC In Figure 1 the block diagram of the conventional DTC is presented for simulation. The minimum values of flux and torque ripples calculated from Equations 7 and 12 are 0.017 Wb

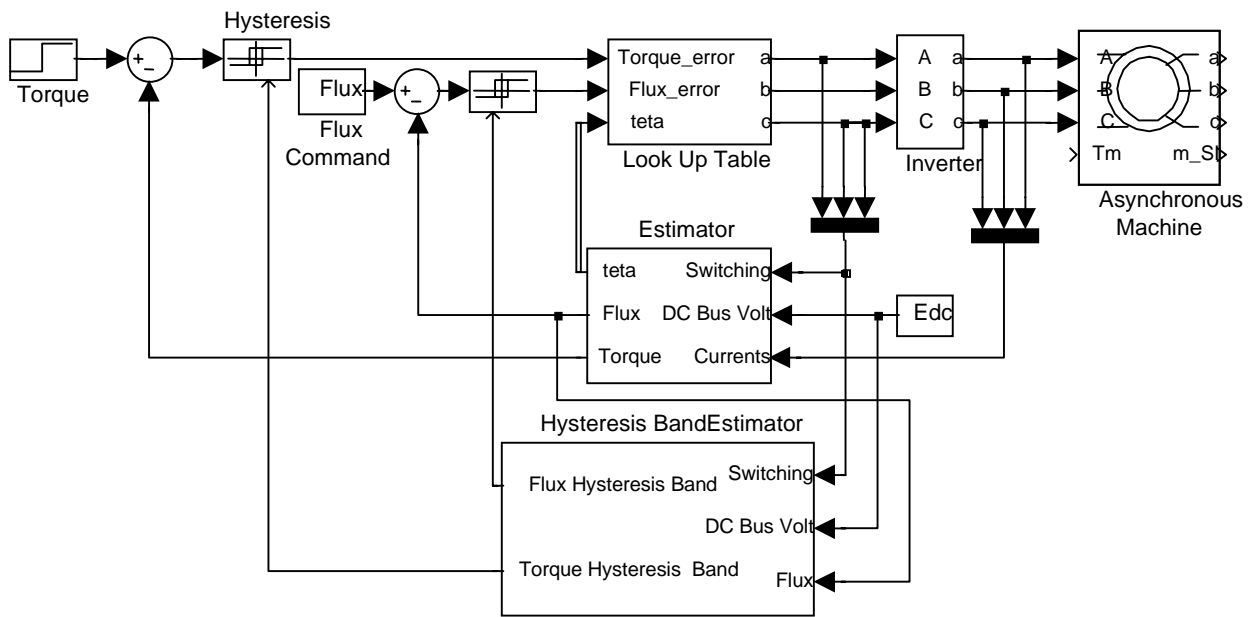
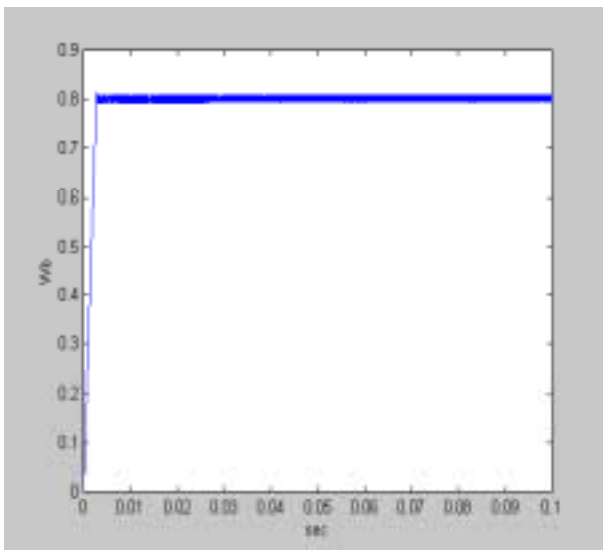
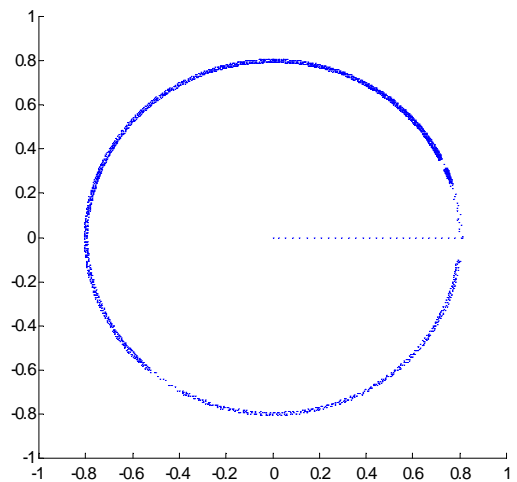

Figure 2. Block diagram of the proposed DTC.



(a)



(b)

Figure 3. Stator flux for conventional DTC, $\Delta\psi=0.002\text{Wb}$; a) flux magnitude, b) flux locus.

and 0.78 Nm respectively. Figure 3 shows the flux response of conventional DTC for a flux hysteresis

band of 0.002 Wb where the band amplitude is less than the minimum value of flux ripples. The

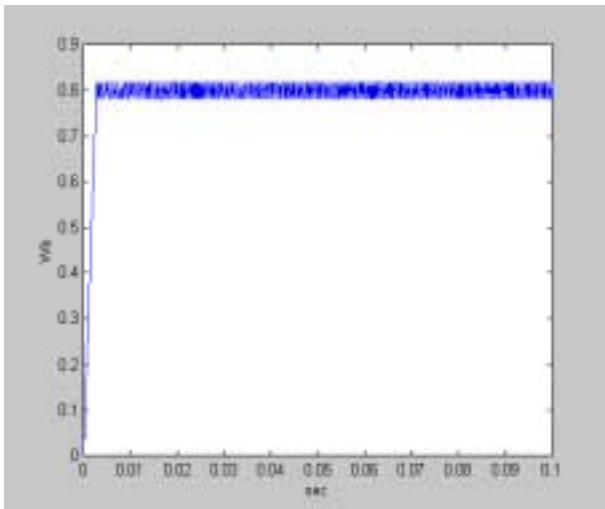

(a)

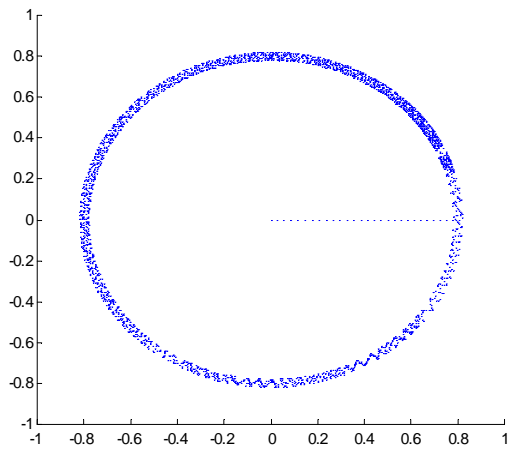

(b)

Figure 4. Stator flux for conventional DTC, $\Delta\psi=0.029$ Wb; a) flux magnitude, b) flux locus.

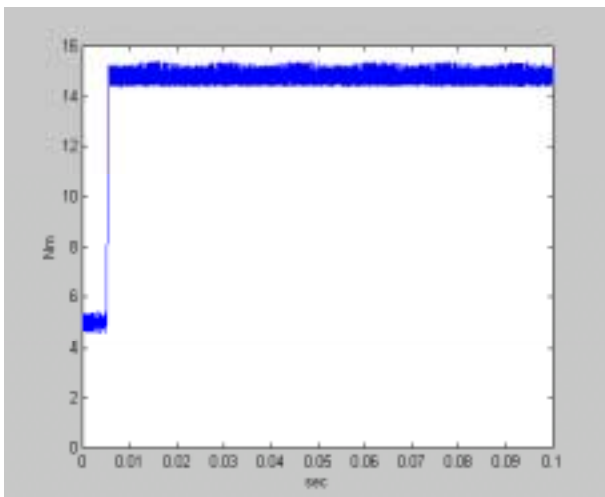

(a)

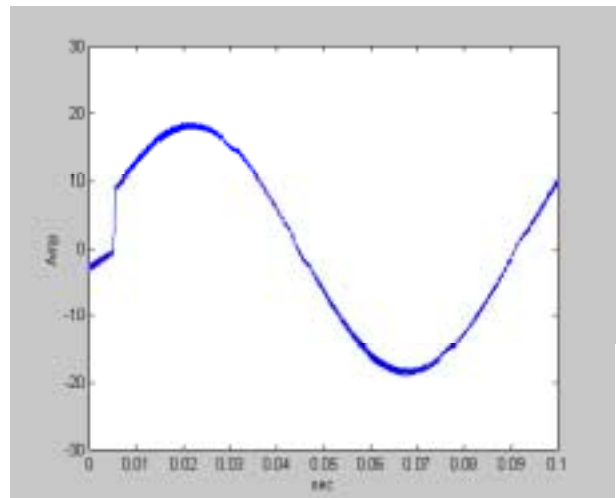

(b)

Figure 5. Electromagnetic torque and line current for conventional DTC, $\Delta T = 0.009$ Nm.

switching frequency is limited to 20KHz and the flux ripples exceed the hysteresis band up to 0.017 Wb. Figure 4 shows the flux response for a hysteresis

band of 0.029 Wb, which is higher than the minimum value of flux ripples. It is seen that the flux ripples reach to about 0.037 Wb, which is much more than

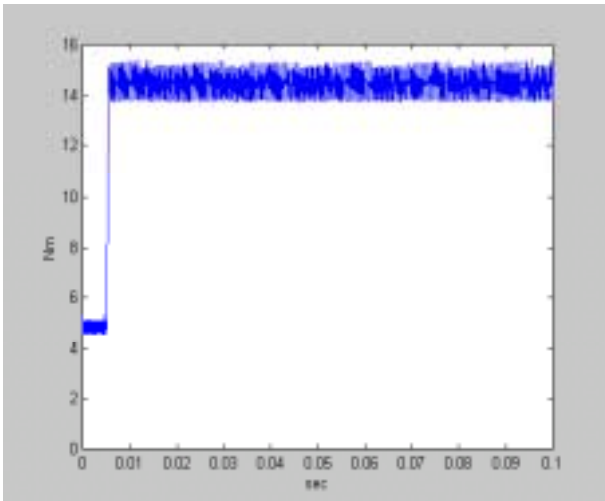

(a)

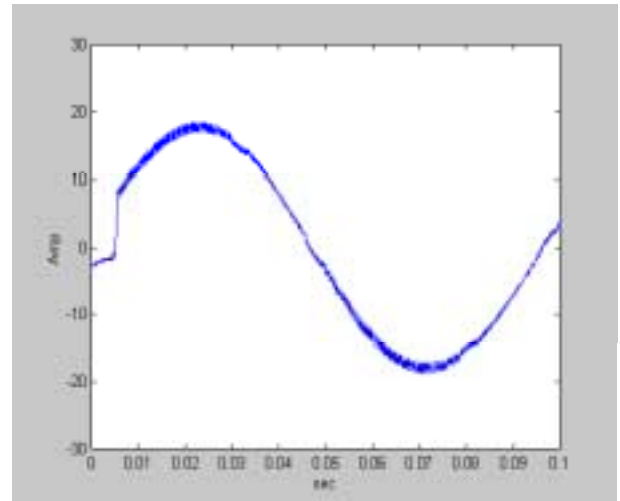

(b)

Figure 6. Electromagnetic torque and line current for conventional DTC, $\Delta T=1.45$ Nm.

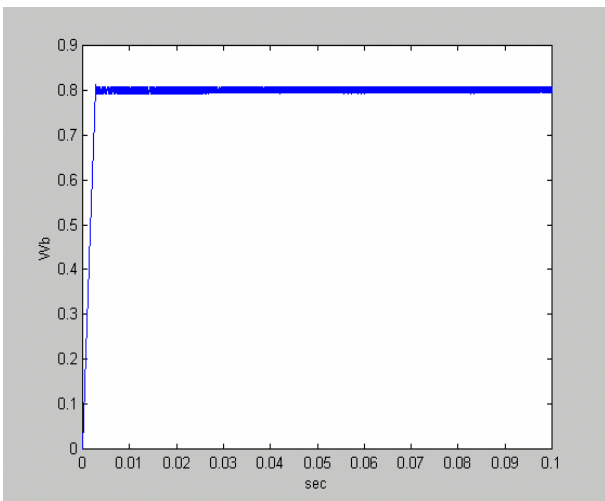

(a)

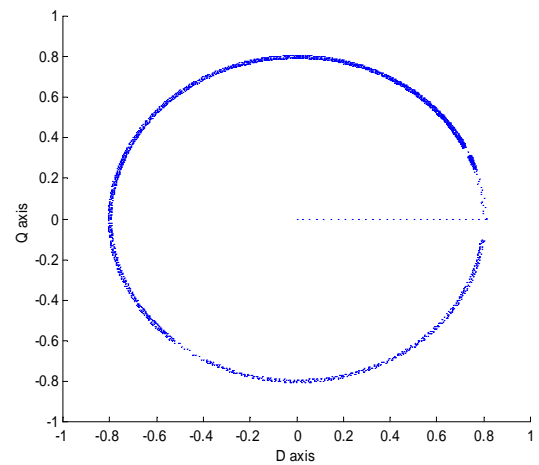

(b)

Figure 7. Stator flux for proposed DTC; a) flux magnitude, b) flux locus.

the minimum value of flux ripples. This is in accordance with Equations 8.b.

The torque response is shown in Figure 5 for a very small torque hysteresis band of 0.009 N-m and

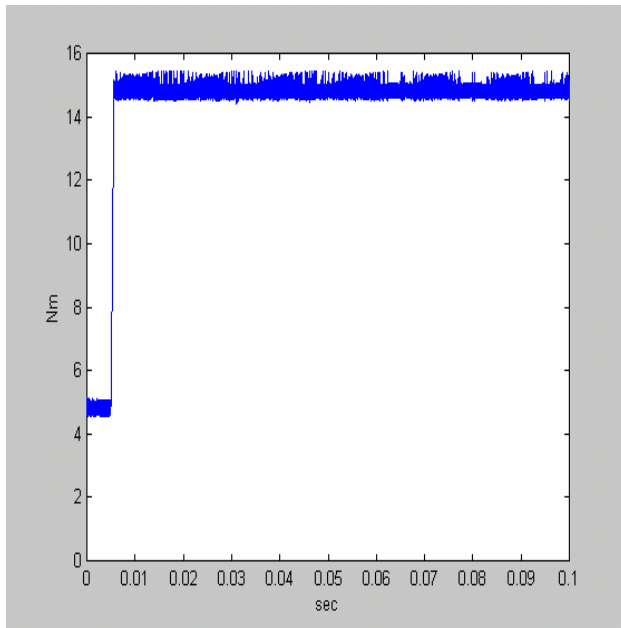

(a)

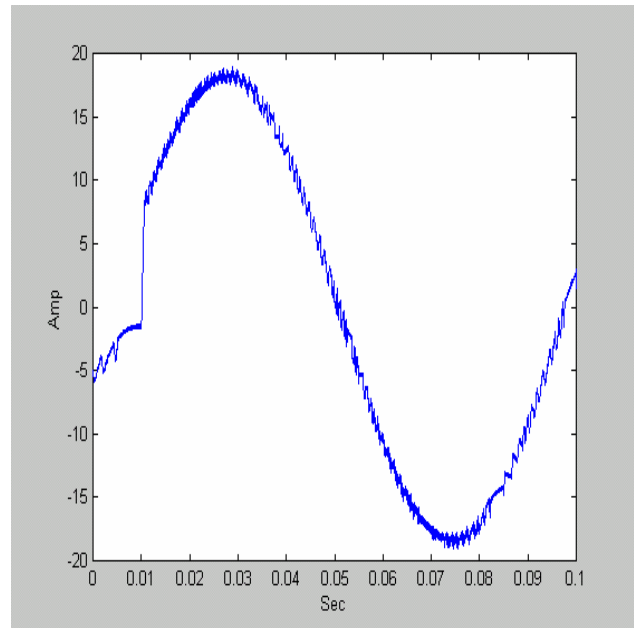

(b)

Figure 8. Electromagnetic torque and line current for proposed DTC.

the same limit for the switching frequency. It is seen that the torque ripples exceed the hysteresis band since the switching frequency is limited. Figure 6 shows the torque response for a higher hysteresis band of 1.45 N-m. The torque ripples clearly exceed the minimum value of torque ripples. The motor line current is also shown in Figure 5 and Figure 6. It is seen that the current ripples are higher when a higher band is chosen.

B. The Proposed DTC The simulation results of the machine performance under the proposed DTC method are presented here based on the Simulink block diagram of Figure 2. The results are then compared with the ones obtained from the simulation of conventional DTC presented above. The same frequency limit and sampling time as the conventional DTC case are used.

The hysteresis band estimator determines the optimal values of the flux and torque hysteresis bands from 14 and 15 as described in section IV. Figures 7.a and 7.b show the stator flux magnitude and its vector locus respectively. It is seen that the peak of flux ripple is limited to the minimum value of 0.017 Wb as a result of on-line determination of an optimal flux hysteresis band.

Comparing Figure 7 to Figure 3, it is evident that the same value of peak flux ripples is achieved with a higher flux hysteresis band, thus reducing the average inverter switching frequency. Also comparing Figure 7 to Figure 4 it is clearly seen that a lower value for peak of the flux ripples is obtained by the proposed method with the same switching frequency limit.

Figure 8.a shows the electromagnetic torque of the motor under the proposed DTC control.

Comparing this figure to Figure 5, it is evident that the average switching frequency is lower in the proposed DTC. Also comparing Figure 8 to Figure 6, it is seen that the peak value of torque ripples is reduced to a much lower value. The improvement of torque ripples in the proposed method is due to the on-line adjustment of torque hysteresis band to an optimal value. The line current value is also shown in Figure 8.b. A less current distortion is evident in this figure in comparison to Figure 6.b (note that the current scale in Figure 8.b is less than the scale in Figure 6.b).

Therefore, the simulation results presented above prove that the on-line determination of optimal hysteresis bands provides a desirable operation regarding the peak value of flux and torque pulsations and the average inverter switching frequency. This results in a smoother and more efficient motor drive system operation.

6. CONCLUSIONS

The flux and torque hysteresis band amplitudes in direct torque control of induction motors highly affect the magnitude of torque and flux ripples. Choosing high values for these bands results in increased ripples, while low values of the bands increase the inverter switching frequency.

In this paper the effects of flux and torque hysteresis bands on the magnitudes of flux and torque ripples are analyzed first. A new method is then proposed for the on-line determination of optimal values of the bands for a limited switching frequency.

These bands result in reduced flux and torque ripples or reduced inverter switching as confirmed by extensive simulation results presented in the paper. Therefore the proposed DTC method provides an opportunity for motor operation under reduced inverter switching loss, less motor harmonics loss and lower noise, thus contributes to a more efficient and smoother motor drive system.

7. ACKNOWLEDGMENT

The authors wish to thank the University of

Tehran for supporting this work through the research project 612/1/534.

8. APPENDIX

A. Nomenclature

T_e = electromagnetic torque

\overline{V}_s = stator voltage vector

T_s = sampling time

T_{sw} = minimum switching time

ΔT = torque hysteresis band amplitude

$\overline{\Psi}_s$ = stator flux vector

$\Delta \Psi_{ripple}$ = flux ripple amplitude

ψ = flux hysteresis band amplitude

B. System Parameters

$R_s=0.$

$R_r=1 \Omega$

$L_s=0.105 \text{ mH}$

$L_r=0.105 \text{ mH}$

$L\sigma=5 \Omega$

$\psi_s=0.8 \text{ Wb}$

$P= 4$

$E_{dc}=280 \text{ v}$

$f_{\text{samp}}=40 \text{ Khz}$

$M=0.001 \text{ H}$

9. REFERENCES

1. Casadei, D., Grandi, G., Serra, G., Taxi, A., "Effects of Flux and Torque Hysteresis Band Amplitudes in Direct Torque Control of Induction Machines", *Proceedings of IEEE IAS*, (1994), 299-304.
2. Habetler, T. G., Profumo, F., Pastorelli, M., Tolbert, L. M., "Direct Torque Control of Induction Machines Using Space Vector Modulation", *IEEE Transactions on Ind. App.*, Vol. 28, No. 5, (September/October 1992), 1045-1053.
3. Yongdong, L., Jianwen, S., Baojun, S., "Direct Torque Control of Induction Motor for Low Speed Drives Considering Discrete Effects of Control and Dead Time of Inverter", *Proceedings of IEEE IAS*, (1997), 781-788.
4. Grabowski, P. Z., "Direct Torque Neuro Fuzzy Control of Induction Motor Drive", *Proceedings of IEEE IAS*, (1997), 557-562.
5. Nogushi, T., Yamamoto, M., Kondo, S., Takahashi, I., "High Frequency Switching Operation of PWM Inverter for Direct Torque Control of Induction Motor", *Proceedings of IEEE IAS*, (1997), 775-780.

6. Takahashi, I., Nogushi, T., "Take a Look Back Upon the Past Decade of Direct Torque Control", *Proceedings of IEEE IAS*, (1997), 546-551.
7. Purcell, A., Acarnly, P., "Device Switching Scheme for Direct Torque Control", *Electronic Letters*, (1998), 412-414.