



Web Control and Monitoring System: Experimentation with *Haematococcus Pluvialis*

L. M. Beltran, C. L. Garzon-Castro*, D. F. Valencia, V. A. Uribe

Engineering Faculty, Informatics Engineering Program, CAPSAB Research Group, Universidad de La Sabana, Campus Universitario del Puente del Común, Km. 7 Autopista Norte de Bogotá, Postal Code 11001000, Chía (Colombia)

PAPER INFO

Paper history:

Received 26 July 2012

Received in revised form 6 September 2012

Accepted 18 October 2012

Keywords:

Bioreactor

Control System Design by Computer

System Monitoring

Computer Applications

Microalgae

ABSTRACT

This paper presents both, the design and development of a monitoring and control system via web for a closed microalgae crop and the results that were obtained using the strain *Haematococcus pluvialis*. The research was done at Universidad de La Sabana (Colombia) and it aimed at quantifying the growth kinetics associated with the increment of biomass and the development of red pigment inside the cells when exposed to different wavelengths (λ), constant temperatures, agitation and cycles of light/darkness over the crop. It was found that for short wavelengths (470nm -blue light) the cell size, the quantity of red pigment and the growth kinetics were higher than the crop illuminated with green light (525nm). All of the above was established thanks to SICOMOAL system which allowed real time control and monitoring without human interference. This increases the reliability of the bioprocess data and gains more efficiency in this kind of research.

doi: 10.5829/idosi.ije.2013.26.03c.01

1. INTRODUCTION

Becker et al. [1] reported that both for academy and industry, the use of control systems and automatic control of different bioprocesses have incremented. According to Amigo et al. [2], the monitoring and automatic control of the physical and chemical parameters are necessary to optimize a bioprocess. The application of control strategies for photo bioreactors (PBR) used on microalgae crops has been recently popularized with the installation of real-time management systems by computers, which is important for the commercial viability due to the valued information provided to improve the production process and the reduction of costs [3-5]. Capraro et al. [6] say that although the tools related to the virtual or remote laboratories that exist in the different fields of engineering are enough, most of them are commercially expensive because they are designed and implemented for mass production or industrial scales and are not economically viable if they are needed in a laboratory, i.e. for an educative institution research.

Therefore, it was decided to develop a low-cost system that allows automatic control and management of temperature and cycles of light/dark in a closed microalgae crop via web. The greatest contribution was that this system permitted changing conditions of experimentation over the crops of microalgae and work on the bioprocess under defined conditions in a closed system to stimulate the influence of the different parameters over them.

With this system, it was sought to maintain control over some conditions of experimentation of the microalgae crop, 24 hours a day, and to take data on the required intervals of time, to know records of information at any time, verify the state of the process continuously and change the conditions of experimentation, all of this, via web.

The system was proved on a specific experiment whose main purpose was to determine the wavelength that would produce a higher growth kinetic and a higher quantity of cells with red pigment associated to the Astaxanthin using the *Haematococcus pluvialis* microalgae, considered as the best natural resource of the named substance. Katsuda et al. [7], have stated that the Astaxanthin is used as an additive in aquaculture and foodstuff industries; in pharmaceutical and

*Corresponding Author Email: claudia.garzon@unisabana.edu.co (C. L. Garzon-Castro)

nutraceutical products because it exceeds the antioxidant benefits of the β -carotene, zeaxanthin, canthaxanthin, vitamin C and vitamin E. Lorenz et al. [8] and Guerin et al. [9] reported that astaxanthine is also used as skin protector against the effects of the ultraviolet rays, against chemically induced cancer as well as to increase the magnification of high density lipoproteins and to improve the immunological system.

1. 1. The Effect of Light and Temperature on the Microalgae Growth

According to Vonshak et al. [10], any change on the environmental variables determines the answer of the cell to certain type of stimuli, limiting factors or stress; this indicates that extreme factors such as temperature changes and cycles of light/dark could affect significantly the reproduction process and the growth of microalgae.

In turn, Pulz [11] says that the maximum productivity of the crop can be reached only in the optimal point of a specific temperature for the microalgae specie in experimentation since this variable generates an influence over the respiration and photorespiration processes in a more intensive way than photosynthesis.

During the experiments, each PBR was illuminated with a different wavelength, the system must guaranteed a determined temperature for the crops and the cycles of light/dark were handled as a perturbation.

2. GENERAL ARCHITECTURE OF SICOMOAL (SISTEMA DE CONTROL Y MONITOREO VÍA WEB PARA MICROALGAS)

SICOMOAL is a system that permits: controlling temperature inside the crop medium, managing the cycles of light/dark as a perturbation on the PBR, and monitoring the temperature in the reference PBR; this was controlled remotely via web 24-hours. Gupta et al. [12], say the performance of the system depends on the configuration and performance of its subsystems. Figure 1 shows the basic systems and subsystems configuration of SICOMOAL: 1) software and 2) hardware: (a) cards of: acquisition of data (DAQ) and power supply of actuators, (b) sensors and actuators, (c) video camera and (d) production system.

2. 1. Software Overview

The software was developed in modular Java, under the concept of multi processes or multithreading. The first module corresponds to an application that communicates with the DAQ cards using the port RS232 of the PC, making readings every 5 seconds. This way, it recollects signals sent by the sensors which are stored according to the sampling programmed time. Then, this information is compared with the reference values so it can take the relevant decision with the purpose of controlling the

temperature and activate or deactivate the cycles of light/dark.

The second module is a web application where the whole system can be controlled, the configurations can be set for each experiment, the data stored by the system can be accessed, the video camera can be handled, and permissions can be given to other users according to the assigned profile: administrator or observer. Part of the GUI is shown in Figures 2 and 3.

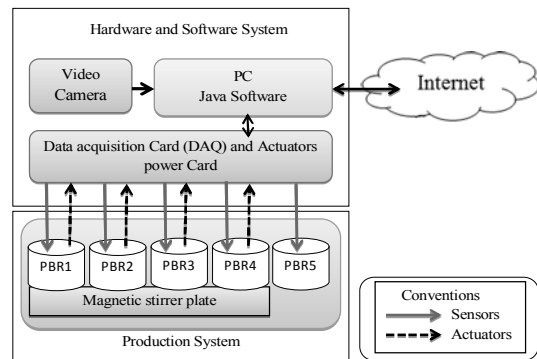

Figure 1. System configuration for SICOMOAL

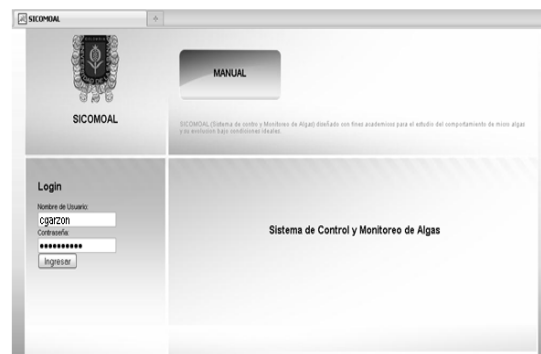

Figure 2. Login GUI

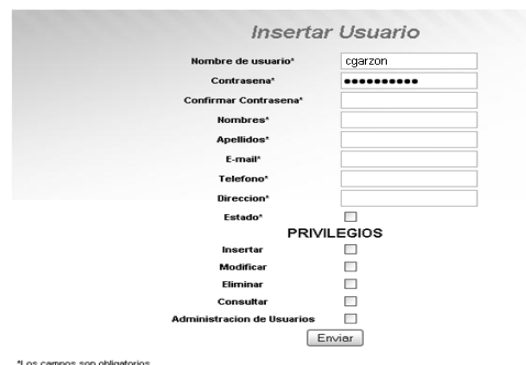

Figure 3. GUI for user insertion and assignment of privileges

2. 1. 1. Structure and Interrelation of the Modules

The web module is constituted of two cores; the first one captures the values of the variables to configure the conditions on a specific experiment and stores those values in a data base; the second one permits monitoring the system state and the history of the collected data up to a specific moment, and the analysis of the information thrown by this data stored on the data base.

The control module is a process that runs continuously (thread) collecting data from the sensors according to a pre-programmed frequency in the settings, comparing those values with the configuration parameters stored in the DB and doing the necessary adjustments on the system to keep the values under the configured ranges. Figure 4 shows the scheme of the process that is executed inside the thread.

2. 1. 2. Process Diagram

The cycle is executed a specific number of times per minute while the system remains in execution, this frequency is programmed on the configuration with the frequency of data sending to the DB, that means that it could make a reading of the sensors every 5 seconds but the data can be stored with any other timing frequency. Figure 5 shows the process described above.

2. 2. Hardware Overview

The hardware was developed for the experiment. The minimum specifications needed for the computer (PC) to use the software that acts as a controller are shown in Table 1. The PC works as a controller so it is used to define the conditions of experiment: sampling time of the temperature, referenced value of the temperature, time of the cycles of light/dark, visualization of the real-time video and managing via web of the system. The PC has to be turned on 24 hours during the experimentation time so the bioprocess can be monitored and controlled continuously.

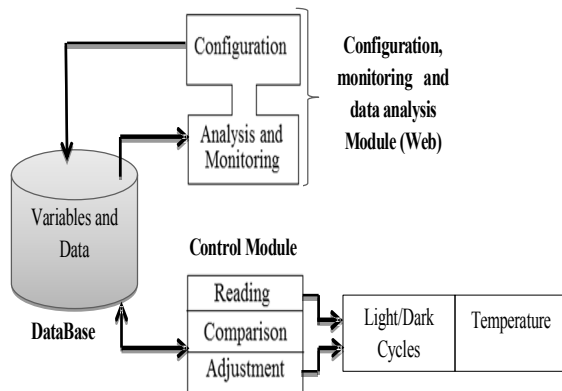

Figure 4. Configuration of the software module and its interaction with the DB on its different phases of execution

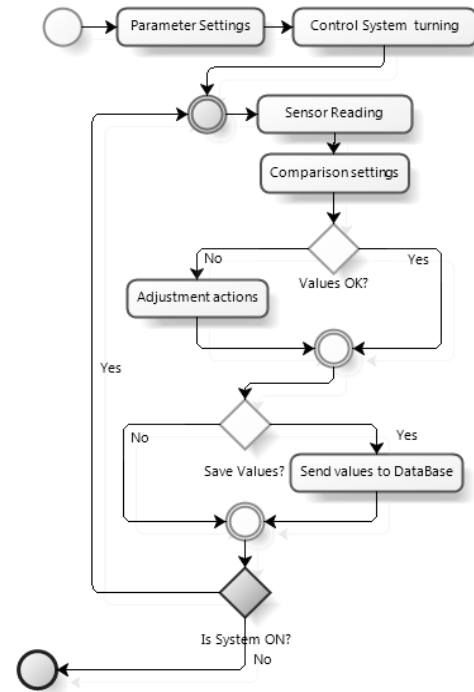

Figure 5. Diagram of the process for the execution of the thread during the cycles of monitoring and control

TABLE 1. System requirements of the PC

SYSTEM REQUIREMENTS	
Operating System	MS Windows XP
Processor	1GHz
RAM Memory	1Gb
Hard Drive	20Gb
WEB Browser	Firefox or Chrome
Java	JDK 6.0
Tomcat	Tomcat 6.x
MySQL	My SQL Server 5.1

2. 3. Data Acquisition Card (DAQ) and Power Board for the Actuators

Both DAQ and power board for the actuators was developed for the experiment; each of the boards is characterized by:

- DAQ. The levels of operation for capturing and shipping data through the RS232 port and USB Port are TTL. The data capture and transmission of the information frames can be done every 100ms if it is required. It also has 8 pines of digital inputs, 8 pins of analog inputs and 8 pins of digital outputs.
- Power board for the actuators. Elevates TTL voltages that receives from the DAQ and supplies 12 V output to the corresponding actuator.

2. 4. Sensors and Actuators As it was necessary to control the temperature of the crop environment on each of the PBR to keep them in the programmed value, an integrated circuit sensor (CI) LM35 of National Semiconductor was used, and it was covered with heat shrinkable material to be submerged on the environment.

To manage the effects of the cycles of light/dark and temperature control, the following actuators were used:

- Light-Emitting Diode Surface Mount Device extensions (LED SMD). These ones were controlled by time; they had to be activated for 18 to 24 hours while the experiments were running. But if it is required to change the relation of hours that each of the extensions is lit, the user can make the respective changes using the interface of the web module. Given by the activation of the LED SMD extensions configuration, while the PBR was inside the cylinder, it was guaranteed a uniform light exposition on the crop (see Figure 6).
- FAN Cooler. Each fan was activated when the temperature exceeded the set point value. These ones were located above each PBR, causing the air to recirculate from the bottom to the top generating heat transfer forced by convection by the respective vent holes (see Figure 7).

2. 5. Video Camera Looking for a sensation of being at the laboratory, a 1.3 Mpx video camera over each PBR was used, so that the cycles of light/dark and the activation of the fan coolers were monitored according to the programmed settings.

2. 6. Production System The production system was composed of: 1) five PBRs and 2) a stir plate. Five PBRs were implemented, four of them were controlled and one was used as reference that didn't have any artificial lighting, temperature control or agitation.

Figure 8 shows the physical characteristics of the PBR: 1) beaker of 10.5 cm diameter and 14 cm height, 1 L capacity and a working volume of 800 ml; 2) one cover of transparent acrylic with 6 holes – 4 used for gas interchange, 1 for the temperature sensor, 1 used for central lighting - ; 3) central lighting provided by LED SMD extensions; 4) external lighting given by an extension rounding the PBR, as shown in Figure 6. The LED SMD extension was located at 1cm away from the PBR, which means that it didn't have any contact with the PBR so the microalgae were not attached to the light source.

A VELP Scientifica stir plate was used as a magnetic agitator.



Figure 6. Location of the LED SMD extensions

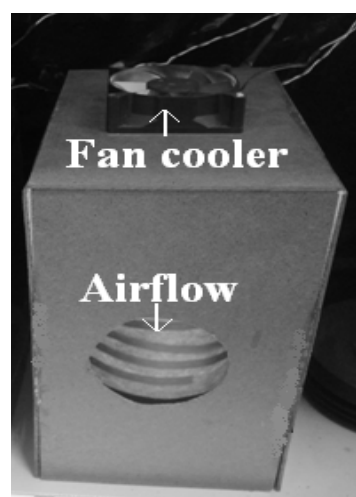

Figure 7. Location of the FAN Cooler in each PBR to guarantee heat transfer forced by convection

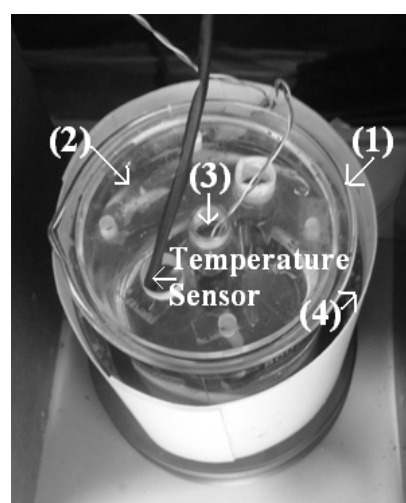

Figure 8. Physical characteristics of each PBR

3. CONTROL SYSTEM

According to Alamatian et al. [13], SICOMOAL is an active control system, because control forces are generated and applied by an external source (actuator) to the structure.

The temperature control implied the operation with: closed-loop structure, state sequence controller and action of the final control element (actuator) discrete (ON/OFF) type, see Table 2.

Four controllers were implemented, one for each PBR. Each PBR was considered as a mono-variable and SISO (Single Input Single Output) system. For temperature controlling, a sensor was located inside each PBR. When the controller detects a temperature value for the crop $T_S(k)$, above the sampling value $T_i(k)$, it immediately activated the corresponding fan cooler $AV_N(k)$ (with $N=1,2,3,4$), until the value of temperature went below the established set point, operating as a discrete mode (ON/OFF). The error margin of temperature obtained was $\pm 1^\circ\text{C}$ due to the delay time of the control loop. In Figure 9 the block diagram for the controlled PBR is shown.

4. EXPERIMENTATION CONDITIONS

Each preliminary experiment was done in triplicate in one of the laboratories of the Engineering Faculty of the Universidad de La Sabana located at 2600 m above sea level, at an average temperature of 14°C . The microscope used to take the photographs was a Nikon Eclipse 80i, with a DS-Fil camera and a DS-U2 controller.

The settings of SICOMOAL for each experiment were characterized by: a set point temperature of 24°C on the controlled PBR, a temperature monitoring for the sampling PBR, a perturbation supply corresponding to the cycles of light/dark (18 light hours/6 dark) given only by the extensions of LED SMD at different wavelengths (see Table 3) and data sampling every hour.

The conditions for the experimentation that were not taken and managed by SICOMOAL were: agitation speed of 720 rpm, duration of each experiment: 15 days, green microalgae *Hematococcus pluvialis* (2505) obtained from a collection of Texas University (UTEX), initial inocula of 1.25×10^3 cells/ml of *H. pluvialis*, broth MES-Volvos suggested by UTEX (see Table 4), and 800 ml of the working environment.

By maintaining a temperature, the cycles of light/dark and the constant agitation speed; it was sought to quantifying the growth rate associated to the increment of biomass when the cells are exposed to different wavelengths (λ).

TABLE 2. Control laws of state sequence established on SICOMOAL

CONTROL LAWS OF STATE SEQUENCE	
$T_S(k) - T_i(k) > 0$	$\rightarrow AV_N(k) = 1$
$T_S(k) - T_i(k) \leq 0$	$\rightarrow AV_N(k) = 0$
$t_i \leq t < t_r$	$\rightarrow A_i(k) = 1$
$t < t_i \vee t \geq t_r$	$\rightarrow A_i(k) = 0$

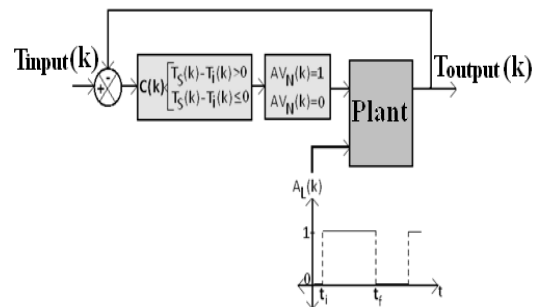

Figure 9. Block diagram of the temperature control system and cycle of light/dark supply for a PBR.

TABLE 3. Working wavelengths to illuminate the crop *H. pluvialis*

LED SMD EXTENSIONS	λ (nm)	λ_{\max} (nm)
Red	560–700	625
Green	430–610	525
Blue	390–550	470
White		

TABLE 4. Composition of each liter of the crop environment

COMPONENT	QUANTITY
$\text{Ca}(\text{NO}_3)_2 \cdot 4\text{H}_2\text{O}$	1 mL/L
$\text{MgSO}_4 \cdot 7\text{H}_2\text{O}$	1 mL/L
$\text{Na}_2\text{glycerophosphate} \cdot 5\text{H}_2\text{O}$	1 mL/L
KCl	1 mL/L
MES	1.95g/L
Solution P-VI Metal	6 mL/L
NH_4Cl	1 mL/L
B_{12} Vit	1 mL/L
Biotina Vit	1 mL/L

5. RESULTS AND DISCUSSIONS

SICOMOAL permitted maintaining the needed conditions on different crops of microalgae that were carried out for 7 months. During this time, the crops

were not contaminated, which happened when the system did not exist, because it implied more manipulation and personal interaction with the crop to perfectly keep the variables of the process (24°C and cycles of light/dark of 16/8 hours).

The results that were obtained affirm the importance of the this kind of prototypes; thanks to the achieved goals such as: reproducibility in the routine, more efficiency to the physiological researching analytical-casual and the verification of the process models, researchers' time optimization due to the automatic control of the bioprocess and the advantage of controlling and monitoring the process at any time at any place.

Guaranteeing the continuous work with the desired values of the process variables chosen (temperature and cycles of light/dark) is vital for the bioprocess because, in the case of submission of an increment of the temperature, it could produce cell death if the value overpasses 34°C for more than 8 hours specially in the initial phase of the experiment (first 4 days), which will imply, in turn, a minimum delay of a week or even a month of experimentation, depending whether or not if there is enough inocula.

The effectiveness of the prototype was measured through the measurement of the growth kinetic and the generation of the red pigment associated with the Astaxanthin of the *H. pluvialis* crop according to the different values of wavelength employed as light source. The biological results are described below.

5. 1. Morphologic Change *H. pluvialis* is a Chlorophyta microalga that belongs to the Chlorophyceae class, has a complex cellular cycle with a variety of cell forms that change according to the crop environment. Katsuda et al. [7] reported that there are three types of cells: green and oval flagellated that is denominated as vegetative; a green spherical cell, without flagella denominated palmella; another red spherical cell without flagella called Cyst or Aplanospora. Fabregas et al. [14] reported that these morphologic changes can be induced under conditions of stress as high temperature, nutrient deficiency and according to Kobayashi et al. [15] high light intensity also affects.

Each morphologic change was observed during the experimentation and it could be appreciated by accumulation of Astaxanthin in the last cellular phase. In its first phase, the microalgae were green, oval and moved with the help of its flagella. In the second phase, the form was spherical and the flagella disappeared so there was less movement; the third phase appeared when the cell was fully red and spherical (see Figure 10).

5. 2. Specific Coefficient and Growth Kinetic

The biomass values were measured by direct

quantification using the camera of Neubauer and a Nikon Eclipse 80i microscope. Equation (1) was used to calculate the coefficient of maximum specific growth of the crop (μ_{\max}), taking into account: 1) the size of the population at the end of the interval of time (x), 2) the size of the population at the beginning of the interval of time (x_0) and 3) the interval of time of the experiment (Δt).

$$\mu_{\max} = \frac{\ln(x) - \ln(x_0)}{\Delta t} \quad (1)$$

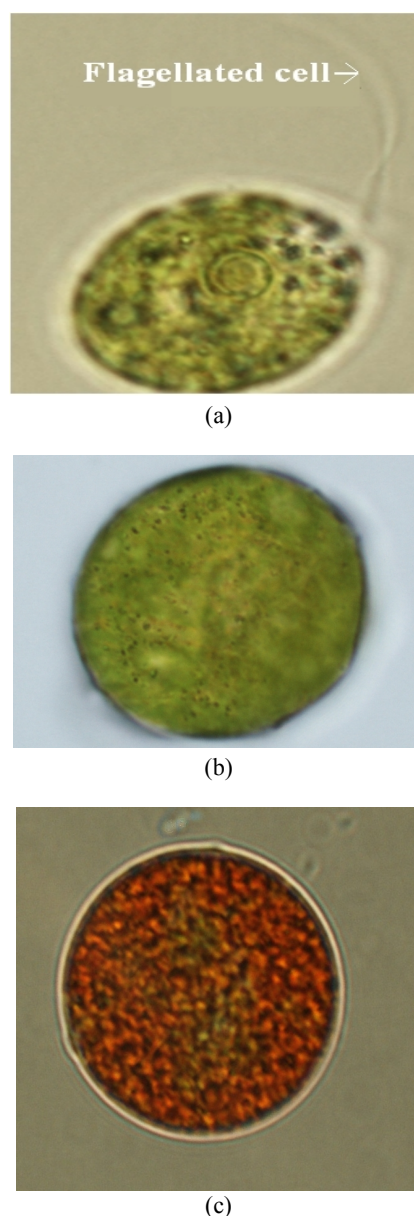

Figure 10. Cellular cycle of *H. pluvialis*. a. Vegetative (first day) b. Palmella (third day) and c. Cyst or Aplanospora (seventh day). Photographs taken with the microscope Nikon Eclipse 80i and a DS-Fil camera

TABLE 5. Specific coefficients of maximum growth at different wavelengths

Specific Coefficients of Maximum Growth (μ_{max})				
PBR ₁ (Red light)	PBR ₂ (Green light)	PBR ₃ (Blue light)	PBR ₄ (White light)	PBR ₅ (No light)
0.357±5.77 E-03	0.323±1.15 E-02	0.640±1.00 E-02	0.487±5.77 E-03	0

*Each value represents the mean of three independent determination.
(±) Standard deviation

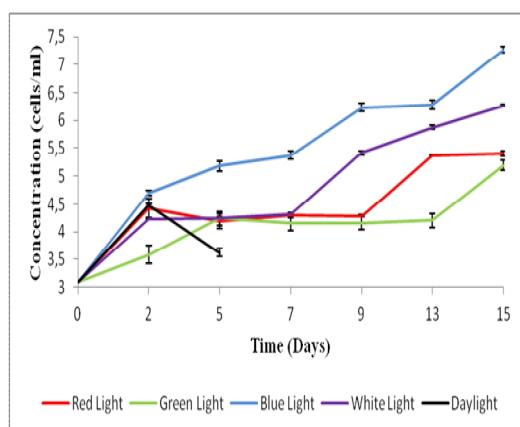

Figure 11. Growth kinetics curves of *H. pluvialis* at different wavelengths. Each value represents the mean of three independent determinations. Error bars indicate the standard deviation

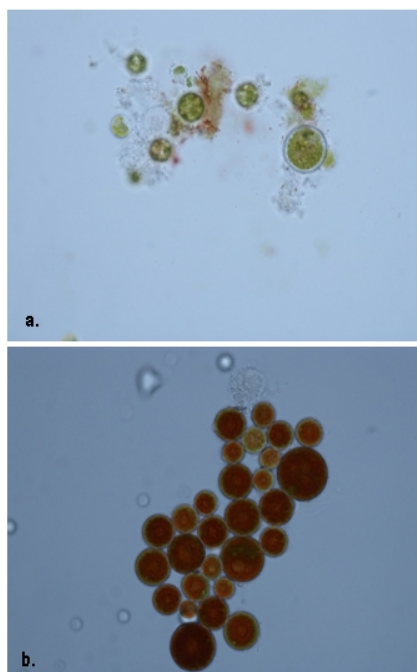

Figure 12. *H. pluvialis* cells on day 15 in the PBR lighted with: a. Red (625 nm) and b. Blue (470 nm). Photos taken with a Nikon Eclipse 80i microscope and a DS-Fil camera

According to the specific coefficients of growth calculated (see Table 5) on each of the crops, it was established that the best growth was found on the PBR lighted with a 470 nm (blue light) wavelength meanwhile there was less growth on the 525 nm (green light) wavelength, probably because of the absorption efficiency of the chlorophyll of the green light, coinciding with the report of Katsuda et al. [16].

while quantification of the growth kinetics measured in number of cells per ml using different wavelengths, it was found that in the reference PBR after day 7 the cells stopped growing and started dying due to the low temperatures that were reported on the monitoring realized by the system at early morning ($16 \pm 1^\circ\text{C}$). As the specific coefficients of growth and growth kinetics curves show in Figure 11, it could be established that it was higher when the cells were illuminated with a short wavelength (470 nm), i.e. blue light that agrees with the reports of Katsuda et al. [17] and Garzon-Castro et al. [18]. Also, the cells lighted with blue light on days 13 and 15 grew compared to the first phases of cellular growth.

5. 3. Red Pigment Cells The Astaxanthin is a secondary metabolite that is produced under conditions of stress, so it was decided to use the light as a stress condition on cycles of light/dark (18/6), using it as an accelerator of the process of accumulation of Astaxanthin reported by Vonshak et al. [10]. After the fourth day, the production of red pigment was seen inside the cells located on the PBR lighted by a 470 nm wavelength. At the end of the experiment, the cells exposed to that wavelength increased the red pigmentation considerably, which agreed with the reports of Lababpour et al. [19, 20] which implied that the short wavelengths (380-470 nm) could induce the accumulation of high quantities of Astaxanthin in *H. pluvialis*; meantime in the PBR lighted with red light and green light, most of the cells did not produce red pigment. In addition, it was concluded that the accumulation of Astaxanthin implied a decrease of cell growth, which agreed with Katsuda et al. [16]. In Figure 12, some *H. pluvialis* cells of day 15 can be appreciated, observing that there was less quantity of cells on the PBR lighted with red light, besides that they did not turn red; meanwhile the number of cells found in the PBR lighted with blue light was more that they all turned red.

The efficiency of the illumination in a range of 380-470 nm for the production of Astaxanthin was confirmed, because between the fourth and fifth day there were changes on the cell color (green to red). Even though some authors such as Katsuda et al. [16] and Beltran et al. [18] found that red LEDs serve as cell growth and the blue help morphologic changes and produce Astaxanthin, on this non axenic crop the behavior was not the same.

6. CONCLUSIONS

Use of SICOMOAL allows being assured on the results of different crops, because there is a continuous and rigorous controlling and monitoring of the different variables of the process guarantying the quality and the reproducibility of the bioprocess. The web handling helps the complementation of this kind of development and research as it is not necessary to be in the laboratory, saving time, allowing the continuous checking of the system.

The automation guarantees the quality of the bioprocesses and optimizes the researchers' time, incrementing the reproducibility of the routinely production processes, allowing more efficiency for the physiological and casual-analytic researching, the verification of the process models and the development of bioprocess.

The utilization of SICOMOAL is restricted to the researches of the Universidad de La Sabana, its use will be restricted as long as it is tested with other strains, as it pretends to find concluding results on the effects of the two variables over the growth kinetics. Moreover, the control over more variables that help the acceleration of this process has started, as: CO₂ and pH. For 2013, it is expected that the prototype will be used to develop other investigations at the doctoral and magister level for both Universidad de La Sabana and collaborating with other researchers of other universities inside and outside the country.

It was determined that the combination of environmental parameters directly influences the growth kinetics of microalgae, the size of the cells, and changing color from green to red (color associated with the production of Astaxanthin).

It was established in this study that LED lights of short wavelength (470 nm) not only generate a greater kinetic growth and induce accumulation of Astaxanthin in axenic crops but also cause suppression of cell growth.

7. ACKNOWLEDGMENT

The authors would like to thank the Universidad de La Sabana for its support during the development of ING-101-2010 project.

8. REFERENCES

1. Becker, T., Hitzmann, B., Muffler, K., Portner, R., Reardon, K., Stahl, F., and Ulber, R., "Future aspects of bioprocess monitoring", *White Biotechnology*, (2007), 249-293.
2. Amigo, J. M., Surribas, A., Coello, J., Montesinos, J. L., Maspoch, S., and Valero, F., "On-line parallel factor analysis. A step forward in the monitoring of bioprocesses in real time", *Chemometrics and Intelligent Laboratory Systems*, Vol. 92, No. 1, (2008), 44-52.
3. Gitelson, A. A., Grits, Y. A., Etzion, D., Ning, Z. and Richmond, A., "Optical properties of *Nannochloropsis* sp and their application to remote estimation of cell mass", *Biotechnology and bioengineering*, Vol. 69, No. 5, (2000), 516-525.
4. Becerra-Celis G., T. S., Joannis-Cassan C., Isambert A., Siguesdidjane H., "Control strategy for continuo microalgae cultivation process in a photobioreactor", in 17th IEEE International Conference on Control Applications., Part of 2008 IEEE Multi-Conference on Systems and Control, (2008).
5. Mozafari, A. and Lahroudi, M., "Modeling and control of gas turbine combustor with dynamic and adaptive neural networks (technical note)", *International Journal of Engineering*, Vol. 21, No. 1, (2008) 71-84.
6. Capraro, F., Tosetti, S. and Vita Serman, F., "Laboratorio Virtual y Remoto para Simular, Monitorizar y Controlar un Sistema de Riego por Goteo en Olivos", *Revista Iberoamericana De Automática E Informática Industrial (RIAI)*, Vol. 7, No. 1, (2010), 73-84.
7. Katsuda, T., Shimahara, K., Shiraishi, H., Yamagami, K., Ranjbar, R., and Katoh, S., "Effect of flashing light from blue light emitting diodes on cell growth and astaxanthin production of *Haematococcus pluvialis*", *Journal of Bioscience and Bioengineering*, Vol. 102, No. 5, (2006), 442-446.
8. Lorenz, R. T. and Cysewski, G. R., "Commercial potential for *Haematococcus* microalgae as a natural source of astaxanthin", *Trends in Biotechnology*, Vol. 18, No. 4, (2000), 160-167.
9. Guerin, M., Huntley, M. E. and Olaizola, M., "Haematococcus astaxanthin: applications for human health and nutrition", *Trends in Biotechnology*, Vol. 21, No. 5, (2003), 210-216.
10. Richmond, A., "Handbook of microalgal culture: biotechnology and applied phycology, Wiley-Blackwell, (2008).
11. Pulz, O., "Photobioreactors: production systems for phototrophic microorganisms", *Applied Microbiology and Biotechnology*, Vol. 57, No. 3, (2001), 287-293.
12. Gupta, S., Tewari, P.C., "Performance modeling of power generation system of a thermal plant", *International Journal of Engineering*, Vol. 24, No. 3, (2011), 239-248.
13. Alamatian, J. and Rezaeepazhand, J., "A simple approach for determination of actuator and sensor locations in smart structures subjected to the dynamic loads", *International Journal of Engineering-Transactions A: Basics*, Vol. 24, No. 4, (2011), 341.
14. Fabregas, J., Domínguez, A., Alvarez, D. G., Lamela, T. and Otero, A., "Induction of astaxanthin accumulation by nitrogen and magnesium deficiencies in *Haematococcus pluvialis*", *Biotechnology Letters*, Vol. 20, No. 6, (1998), 623-626.
15. Kobayashi, M., Kakizono, T., Nishio, N. and Nagai, S., "Effects of light intensity, light quality, and illumination cycle on astaxanthin formation in a green alga, *Haematococcus pluvialis*", *Journal of Fermentation and Bioengineering*, Vol. 74, No. 1, (1992), 61-63.
16. Katsuda, T., Lababpour, A., Shimahara, K. and Katoh, S., "Astaxanthin production by *Haematococcus pluvialis* under illumination with LEDs", *Enzyme and Microbial Technology*, Vol. 35, No. 1, (2004), 81-86.
17. Katsuda, T., Shiraishi, H., Ishizu, N., Ranjbar, R. and Katoh, S., "Effect of light intensity and frequency of flashing light from blue light emitting diodes on astaxanthin production by *Haematococcus pluvialis*", *Journal of Bioscience and Bioengineering*, Vol. 105, No. 3, (2008), 216-220.
18. Beltran, L. M., Garzon-Castro, C. L., Garces, F. and Moreno, M., "Monitoring and Control System used in Microalgae Crop",

- Latin America Transactions, IEEE (Revista IEEE America Latina)*, Vol. 10, No. 4, (2012), 1993-1998.
19. Lababpour, A., Hada, K., Shimahara, K., Katsuda, T. and Katoh, S., "Effects of nutrient supply methods and illumination with blue light emitting diodes (LEDs) on astaxanthin production by *Haematococcus pluvialis*", *Journal of Bioscience and Bioengineering*, Vol. 98, No. 6, (2004), 452-456.
20. Lababpour, A., Shimahara, K., Hada, K., Kyoui, Y., Katsuda, T., and Katoh, S., "Fed-batch culture under illumination with blue light emitting diodes (LEDs) for astaxanthin production by *Haematococcus pluvialis*", *Journal of Bioscience and Bioengineering*, Vol. 100, No. 3, (2005), 339-342.

Web Control and Monitoring System: Experimentation with *Haematococcus Pluvialis* TECHNICAL NOTE

L. M. Beltran, C. L. Garzon-Castro, D. F. Valencia, V. A. Uribe

Engineering Faculty, Informatics Engineering Program, CAPSAB Research Group, Universidad de La Sabana, Campus Universitario del Puente del Común, Km. 7 Autopista Norte de Bogotá, Postal Code 11001000, Chía (Colombia)

PAPER INFO

چکیده

Paper history:

Received 26 July 2012

Received in revised form 6 September 2012

Accepted 18 October 2012

Keywords:

Bioreactor

Control System Design by Computer

System Monitoring

Computer Applications

Microalgae

در این مقاله، طراحی و توسعه سیستم‌های پایش و کنترل تحت وب برای تولید ریزجلبکها به روش بسته آرایه شده است که گونه *Haematococcus pluvialis* به عنوان گونه مورد بررسی برای استخراج نتایج انتخاب شده است. این تحقیق در دانشگاه سابانا (Sabana) در کلمبیا با هدف تعیین نرخ رشد سیستیک مرتبط با افزایش توده سلولی و همچنین تعیین نرخ ایجاد رنگدانه های قرمز درون سلول در معرض طول موجهای (λ) مختلف، دمای ثابت، اختلاط و چرخه های نور/تاریکی بر روی جلبک انجام شده است. یافته های این مطالعه حاکی از آن است که در طول موجهای کوتاه (۴۷۰ نانومتر- نور آبی)، اندازه سلول، کمیت رنگدانه‌های قرمز و سیستیک رشد بیشتر است در حالیکه در تابش نور سبز (۵۲۵ نانومتر) نرخ رشد پایین تر می باشد. فعالیتهای فوق با کمک سیستمی که امکان کنترل و پایش زمان حقیقی را بدون دخالت انسان ایجاد می کرد فراهم گردید. تجربه چنین سیستمی در این مطالعه موجب افزایش اعتبار داده های فرآیند زیستی می گردد و اثربخشی تحقیقاتی از این دست را بیشتر می نماید.

doi: 10.5829/idosi.ije.2013.26.03c.01

