



Behavior and Strength of Steel Fiber Reinforced Self-compacting Concrete Columns Wrapped by Carbon Fiber Reinforced Polymers Strips

S. A. Abbas^{*a}, I. F. Ali^b, A. A. Abdulridha^a

^a Department of Civil Engineering, University of Technology, Baghdad, Iraq

^b The Ministry of Transport and Communications, Baghdad, Iraq

PAPER INFO

Paper history:

Received 17 August 2020

Received in revised form 27 October 2020

Accepted 29 October 2020

Keywords:

Carbon Fiber Reinforced Polymers

Finite Element

Mechanical Properties

RC Columns

Self-compacted Concrete

Steel Fibers

ABSTRACT

Strength capacity of reinforced concrete columns is very important to resist and transmit the external loadings. For Architects the engineering requirements to use small cross section of reinforced concrete columns or in case of poor control quality we need to increase the compressive strength of concrete or use a strengthening technique of the structural elements such as column. In the present paper, the behavior and strength of four steel fiber reinforced self-compact concrete columns reinforced by one layer of CFRP that is wrapped around a square of reinforced concrete columns subjected to static loads is investigated. Self-compacting concrete by using limestone powder is adopted and is mixed with different percentages of steel fiber such as 1%, 1.5% and 2%. Different tests are adopted to investigate the mechanical properties of self-compacted concrete mixed with different steel fiber percentages. Test results show that there is an increase in concrete mechanical properties such as compressive strength, splitting tensile strength and modulus of rupture that reflects on the increase in load capacity of column; specimens when wrapped by CFRP. The increment in columns strength capacity is more than 50% as compared with the control column. All the test specimens are modeled using finite element analysis by ANSYS and the numerical results are compared with tested specimens.

doi: 10.5829/ije.2021.34.02b.10

NOMENCLATURE

A_g	Gross area of section (mm ²)	h	Overall thickness or height of a member (mm)
A_{st}	Total area of longitudinal reinforcement (mm ²)	n_f	Number of plies of FRP reinforcement
b	Width of rectangular cross section (mm)	P_n	Nominal axial load strength at given eccentricity(N)
E_f	Tensile modulus of elasticity of CFRP (MPa)	r	Radius of the edges of a square or rectangular section confined with CFRP (mm)
f_c	Specified compressive strength of concrete (MPa)	Greek Symbols	
f_{cc}	Apparent compressive strength of confined concrete (MPa)	φ	Strength reduction factor (0.85)
f_{fe}	Effective stress in the FRP; stress level attained at section failure (MPa)	ε_{fe}	Effective strain level in FRP reinforcement; strain level attained at section failure (mm/mm)
f_y	Specified yield strength of non-prestress steel reinforcement (MPa)	φ_f	CFRP strength reduction factor (0.95)
f_i	Confining pressure due to CFRP jacket (MPa)	ρ_f	CFRP reinforcement ratio
t	Nominal thickness of one ply of the FRP reinforcement (mm)	ρ_g	Ratio of the area of longitudinal steel reinforcement to the cross-sectional area of a compression member
k_a	Efficiency factor for CFRP reinforcement (based on the section geometry)		

Corresponding Author Institutional Email: 40348@uotechnology.edu.iq (S. A. Abbas)

Please cite this article as: S. A. Abbas, I. F. Ali, A. A. Abdulridha, Behavior and Strength of Steel Fiber Reinforced Self-compacting Concrete Columns Wrapped by Carbon Fiber Reinforced Polymers Strips, International Journal of Engineering, B: Applications Vol. 34, No. 02, (2021) 382-392

1. INTRODUCTION

Reinforced concrete columns are vertical structural elements that the main bearing transfer loads to the foundation. The column stability relies on the Euler formula is that based on the elastic analysis. The column stability depends on the column stiffness and the slenderness ratio. Short columns are classified based on the slenderness ratio. Axially loaded columns are those where the loads lie with the center of gravity of the column cross-section. An increase in compressive strength by adding steel fiber provides the column more strength and reduces the buckling for long term effects. Fibers are planned to advance flexural strength, tensile strength and toughness [1]. The presence of steel fibers makes the concrete matrix less workable such that usage of self-compact concrete is the best solution. Mixing of steel fiber with self-compact concrete as additives material producing a new concrete with special specifications. Self-compact concrete (SCC) is the concrete compacted under its self-weight without use of a mechanical vibrator to stirring the concrete mix.

Many studies concluded that the self-compact concrete is very useful to fill the spaces for heavy structural elements such as columns. Many advantages for self-compact concrete that made the structural engineering adapt for example reduction in time of constructions, no noise, improved the capacity of the structural member by filling the spacing's and giving excellent structural behavior. Superplasticizer is also used in concrete mix to avoid segregations and increase concrete workability. Different methodologies were adapted to strengthen if smaller cross section of concrete and re-strength were used when there is a damage in concrete. Fiber reinforced polymers (FRP) family such as Glass fiber reinforced polymers (GFRP), Armed fiber reinforced polymers (AFRP), Carbon Fiber reinforced polymers (CFRP) and Basalt fiber reinforced polymers (BFRP) has become increasingly popular for structural civil engineering applications. The advantages of FRP family are their high ratio of strength for the weight with corrosion resistance and their ease of use. Many researchers investigated the concrete mechanical properties that are mixed with steel fiber and explored a different structural member with and without wrapped by FRP family. Abdel-Hay [2], investigated the behavior and strength of reinforced concrete columns strengthened by CFRP. Then, test results showed that the ultimate load of the wrapped column increases due to the confinement.

Karbhari and Eckel [3] tested reinforced concrete columns strength by jacket steel section concluded that the main reasons why the designers have not used jackets are low corrosion resistance, increase in dead load and expensive cost. Mirmiran et al. [4] tested concrete columns reinforced by fiber polymer bars in which test results indicated that the large deformation capacity with

low corrosion to environmental gave more attention to use CFRP as an excellent option as an alternative and extremely efficient re-strength technique. Bogdanovic [5] studied the performance of reinforced concrete columns strengthened by FRP strips. Based on the test observations and recorded results, he indicated that the confinement effectiveness of CFRP relies on the concrete type, reinforcement, number and stiffness of FRP layers and loading status. Olivova and Bilcik [6] investigated reinforced concrete circular columns wrapped by FRP, and concluded that when the load was applied as eccentrically; not at the center of the column cross section, the mode of failure of the unconfined columns by CFRP was due to the crushing of the concrete on the compression side. Ou and Truong [7] studied the retrofitted damaged columns, and test results showed that the ductile failure mode occurs when the column was wrapped by CFRP. That means there was an enhancement in lateral strength of reinforced concrete columns. Abdel-Mooty et al. [8] looked out on the behavior of damaged reinforced columns wrapped by FRP columns and concluded that the effectiveness of FRP improvement depends on the level of damage experienced. Ghosh and Sheikh [9] studied reinforced concrete columns wrapped by FRP and concluded that the influence of wrapping in the case of square section columns is more effective than rectangular columns.

Ali et al. [10] investigated the effect of steel fibers on the mechanical concrete properties and the column capacity and found that the presence of steel fiber was adopted in concrete to reduce the cracks due to performing of a plastic hinge in the concrete. Ozturk et al. [11] studied the seismic analysis on the existing building and the methodology that it was adopted as retrofitted by CFRP in which the analysis results indicated that the presence of CFRP decreased the drift that came from lateral loadings. Ozturk et al. [12] studied the retrofit methodology by adopted FRP material on the existing building, analysis results showed that there are improvements in stable maximum drift due to apply of FRP as compared with the control building. Kianoush and Esfahani [13] investigated the axial compressive strength of reinforced concrete columns strengthened by FRP. Test results, the FRP wrap did not increase the strength of square columns with sharp corners. However, the square column with rounded corners exhibited higher strength and ductility compared to those with the sharp corners.

2. AIM AND SIGNIFICANT OF RESEARCH

Different tests for circular columns that were wrapped by CFRP but there were a few researchers that focused on the behavior and strength of square steel fiber reinforced concrete column was using wrapped by CFRP. The aims

and the significance of the present study are to evaluate the mechanical properties of new concrete as steel fiber self compacting concrete and the behavior and strength of wrapped reinforced concrete columns by CFRP sheets under the effect of axial static loadings. Different percentages of steel fiber are adopted such as 1%, 1.5% and 2% added with self-compacting limestone powder to produce a new concrete of steel fiber self compacting concrete (SFSCC). The SFSCC is adapted to cast four short columns wrapped by CFRP to have the same scheme and then tested. Columns capacity, lateral and longitudinal displacement with full behavior for all tested columns are recorded and discussed. Finite element models are simulated for all tested specimens to checkouts the performance of composite columns.

3. THEORETICAL ANALYSIS

Wrapping of CFRP around compression structural members such as reinforced concrete columns will confine the column leading to an increase the strength axial compression load capacity. The presence of FRP strips around compression members also increases the tensile strength of column; also improves the ductility of concrete. The non-prestress concrete with tie reinforcements, the axial load capacity is [14]:

$$\phi P_n = 0.8\phi[0.85\phi_f \hat{f}_{cc} (A_g - A_{st}) + f_y A_{st}] \quad (1)$$

The modified compressive strength of confinement concrete by applies Equation (2) as follows:

$$\hat{f}_{cc} = \hat{f}_c [2.25 \sqrt{1 + 7.9 \frac{f_i}{\hat{f}_c}} - 2 \frac{f_i}{\hat{f}_c} - 1.25] \quad (2)$$

$$f_i = \frac{k_a \rho_f f_{fe}}{2} = \frac{k_a \rho_f \epsilon_{fe} E_f}{2} \quad (3)$$

The reinforcement ratio for adopted square sections calculated as follows:

$$\rho_f = \frac{2t n_f (b+h)}{bh} \quad (4)$$

$$K_a = 1 - \frac{(b-2r)^2 + (h-2r)^2}{3bh(1-\rho_g)} \quad (5)$$

4. EXPERIMENTAL PROGRAM-MATERIALS USED

All raw materials that used to cast the short column specimens were tested using cement, aggregates, limestone powder (LSP) as a filler material for self-compacting concrete and steel fiber as follows:

4.1. Cement Ordinary Portland cement-Type I was used, the test results complying with Iraqi standards specifications IQS No.5-1984 [15]. Tables 1 and 2 list the chemical composition and physical properties of cement.

TABLE 1. Portland cement physical properties

Properties	Results	Iraqi specification, Limits [15]
Specific surface area, m ² /kg	310	> 230.0
Time of sitting by Vicat's apparatus		
Initial, hour: minute	1:41	≥ 0.75 hours
Final, hour: minute	3:45	≤ 10.0 hours
"Compressive strength, MPa"		
3 days	22.6	> 15
7 days	30	> 23
Soundness		
Autoclave, (%)	0.5	< 0.8

TABLE 2. Portland cement chemical composition

Oxide composition	Content (%)	Iraqi specification Limit [15]
Silica dioxide, SiO ₂	21.71	-
Lime, Cao	61.81	-
Iron oxide, Fe ₂ O ₃	3.32	-
Alumina trioxide, Al ₂ O ₃	4.62	-
Sulphates, SO ₃	2.53	< 2.8 %
Magnesia oxide, MgO	3.03	< 5.0 %
Insoluble residue	0.86	< 1.5 %
Loss on ignition	2.14	< 4.0 %
Lime saturation factor	0.84	0.66 to 1.02

4.2. Aggregates Coarse aggregate with maximum size of 12 mm and fine aggregate with maximum size of 4.75 mm were used. The utilized fine and coarse aggregate properties are employed with the Iraqi specification No.45/1984 [16] as publicized in Tables 3 and 4 correspondingly.

4.3. Limestone Powder Limestone powder (LSP) was used as a filler material for the concrete mix as self-compacting concrete with fineness 315 m²/kg that is classified as fine aggregate gradation zone (2). Tables 5 and 6 list the physical and chemical composition of LSP.

TABLE 3. Grading of fine aggregate

Sieve Size (mm)	% Passing by weight	Limits of the IQS. No.45-1984 zone (2) [16]
4.75	100	90-100
2.36	89	75-100
1.18	70.1	55-90
0.60	58	35-59
0.30	24.2	8-30
0.15	3.1	0-10

TABLE 4. Grading of coarse aggregate

Sieve size (mm)	% Passing by weight	Limits of the IQS. No.45-1984 [16]
20	100	100
14	94	90-100
10	61	50 – 85
5	5	0-10
2.36	0	0

TABLE 5. Physical composition of Limestone powder

Physical form	Fine aggregate gradation zone (2)
Color	White
Fineness (Blain) (m ² /kg)	315

TABLE 6. Chemical composition of Limestone dust

Oxide	% Content
Al ₂ O ₃	0.61
SiO ₂	1.22
SO ₃	0.1
Fe ₂ O ₃	0.2
MgO	0.32
CaO	60.1
L.O.I	36.5

4. 4. Super-plasticizer A chemical admixture based on modified polycarboxylic (Glenium 51) was used as a high range water reducing agent plus that matching the requirements of ASTM C-494 [17].

4. 5. Micro Steel Fiber Steel fiber with 15 mm in length, 0.25 mm in diameter and tensile strength (2000 MPa) was adopted.

4. 6. Carbon Fiber Reinforced Polymers (CFRP) Sika - Wrap - 300C woven carbon fiber fabric is used to strengthen specimens.

The roll of carbon fiber was 500 mm in width and 50 m in length (standard roll). Table 7 lists the product description of the (CFRP) as per Sika Company and Figure 1 shows the typical CFRP roll.

4. 7. Adhesive Materials Sikadur-330 was adapted to bonded CFRP sheets with concrete column. Table 8 lists the properties of the used adhesive material.

The Sikadur-330 contained two containers, as A (1 kg) and B (2 kg) mixed with uniform stirring to produce the final bond material with total weight (3 kg).

TABLE 7. Technical properties of CFRP

Properties	Sika Warp-300 C/60
Tensile strength, (MPa)	3900
% Elongation at break, (strain)	1.5%
Areal weight, (g/m ²)	300±15
E-modulus, (MPa)	230000
Density, (g/cm ³)	1.79
Thickness, (mm)	0.166

**Figure 1.** CFRP standard roll**TABLE 8.** Properties of the adhesive material

Density at+23°C (kg/l)	E-Modulus (MPa)	Tensile strength (MPa)	Setting time (Minute) at 35°C	% Elongation
Parts (A+B) mixed: 1.31	Flexural: 3800 Tensile : 4500	30	Part A:part B ratio: 4:1	0.9

5. STEEL REINFORCEMENTS

All columns specimens were reinforced by four rebars as main reinforcements with 10 mm in diameter that were tied by nine 4 mm in diameter. The distribution of tied reinforcements at 115 mm center to center started from 50 mm from each end in addition to two stirrups at each end that was shown in Figure 2. The column was designed based on the ACI-318-2014 [18] in which the concrete column is (415 kN) as ultimate strength capacity without CFRP. The mechanical properties for column reinforcement that tested based on ASTM A996M-05 [19].

6. CONCRETE MIXES

Theoretical mix design was calculated for required compressive strength of concrete with practical trial mix as normal and with additives materials. Slump flow, T50, L-box and V-funnel tests were performed to ensure the concrete working as self-compacting. Furthermore, the results listed in Table 9 were compared with the limitation of EFNARC- 2002 [20] and ACI 237R-07 [21], the SC mix is conforming to specifications.

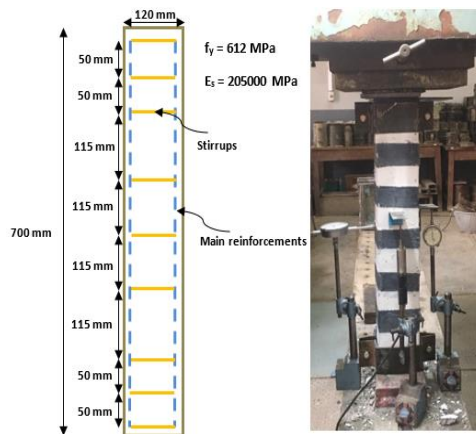

Figure 2. Column dimensions and test setup layout

TABLE 9. Fresh SCC test results [10]

Test method	Results	Range of the EFNARC- 2002 [20]
Slump flow(mm)	710	650-800
T500 (sec)	2	2-5
V-funnel (sec)	9	6-12
L-box (H2/H1)	0.8	0.8-1

7. EXPERIMENTAL PROGRAM

A total of four RC square column specimens were cast and wrapped by CFRP sheets that surrounded the circumference of column and then tested to investigate the effect of steel fiber ratio on the behavior of SCC warped reinforced concrete columns by CFRP sheets. Twenty-four cubes and prisms with dimensions as (150x150x150) mm and (100x100x400) mm respectively were cast and then tested to measure the compressive strength and flexural strength respectively. Cylinders with 150 mm in diameter and 300 mm in height were tested to measure the concrete compressive strength. The characteristics of tested specimens were presented in Table 10. C0%, C1%, C1.5% and C2% represent column specimen with (0, 1, 1.5 and 2)% steel fiber percentages respectively.

TABLE 10. Characteristics of tested specimens

Specimens	Compressive strength (f_c) (MPa)	% Steel fiber ratio	% CFRP by area	CFRP width (mm)
C0%	30	0.0	50	50
C1%	30	1.0	50	50
C1.5%	30	1.5	50	50
C2%	30	2.0	50	50

8. COLUMN SPECIMENS AND TEST PROCEDURE DESCRIPTION

Four tested specimens as a square in cross-section (120x120) mm with column height 700 mm with cover 20 mm are cast in laboratory at the University of Technology in Iraq. The main reinforcements are 4 ϕ 10 mm, and are tied by 9 ϕ 4 mm uniformly distributed with layout. All specimens as short columns are tested by a hydraulic machine capacity of 2500 kN.

Thick steel plates with 7 mm thickness are fixed at top and bottom of each specimen during test to avoid stress concentration and to ensure uniform applied load. The applied load is recorded by a calibrated load and by LVDT-dial gages are used to measure the vertical and horizontal displacement at the top of specimen. The applied vertical load increased incrementally with 10 kN.

9. TEST RESULTS AND DISCUSSIONS

Mechanical properties of a new concrete as SFSCC are investigated for all mechanical properties. The main parameters that were observed during tests are the ultimate capacity of the columns, longitudinal displacements and lateral (buckling) displacements for all columns that wrapped by CFRP assuming that there are full interactions between the CFRP and concrete column and there are no slips.

9. 1. Mechanical Properties

Mechanical properties for SFSCC are obtained by testing cubes, cylinders and prisms to find out the compressive strength, splitting tensile strength and modulus of rupture. The compressive strength of cubes was tested based on the BS1881-116 [22]. Test results showed that there is increment in compressive strength as compared with normal concrete. The increase in compressive strength relies on the steel fiber percentage. When there is increase in the steel fiber percentage that led to an increase in compressive concrete strength because of the steel fiber producing connections between the matrix components and prevent early failure due to reduce the cracks propagations that lead to increase in strength capacity for cubes, cylinders and the columns specimens. Indirect tensile test of SFSCC was carried out based on ASTM C496 [23]. Test results showed that there are increases in splitting tensile strength as compared to normal concrete.

These increased in mechanical properties of SFSCC due to increase in inside tension resistance because increase in ductility and become more strength to prevent internal stresses. Modulus of ruptures test of SFSCC based on ASTM C78 / C78M-16 [24] was performed. It was found that there were increases in modulus of rupture as compared with normal concrete. The presence of steel

fiber within the concrete matrix makes the concrete prism more ductile and resistant due to applied load that means the concrete is not still as brittle so that the SFSCC becomes more flexible. Table 11 lists the test results for all specimens and their comparison with normal concrete.

9. 2. Structural Composite Columns The ultimate capacities of the composite columns are listed in Table 12 increase in load capacities of composite column specimens. Table 12 lists the maximum axial and lateral displacement, and the percentage decrease in deformations.

TABLE 11. Test results for all specimens and their comparisons with normal concrete

Cube		
% Steel fiber	Average compressive strength at 28 days (MPa)	% Increase in compressive strength
0	30	-
1	35	16.67
1.5	38	26.67
2	42	4.00
Cylinder		
% Steel fiber	Average tensile strength at 28 days (MPa)	% Increase in tensile strength
0	3.0	-
1	3.2	6.67
1.5	3.3	10.00
2	3.5	16.67
Prism		
% Steel fiber	Average modulus of rupture at 28 days (MPa)	% Increase in modulus of rupture
0	4.2	-
1	4.5	7.14
1.5	4.6	9.50
2	4.8	14.29

10. MODE OF FAILURE

Figure 3 shows the failure modes for all composite column specimens. The failure modes of composite columns occur in concrete and no pullout or spalling of CFRP at the end for each specimen's tests except specimen C0% in which the CFRP spall from the concrete column. The column C0% crushed at the central height that is mean in the compression face in addition to appears high cracks that propagated near the center of the specimen. Column C1%, crushed at middle with less crack, while composite columns C1.5% and C2% less crush and no CFRP are spalling occurs in middle due to increase in applied load.

Figures. 4 and 5 show the behavior of load versus the longitudinal and lateral displacement up to ultimate loads for all composite column specimens. Initially, the load – displacements behavior starts linear for all specimens. The slope of linear behavior represents the initial stiffness of the composite column is high due to the higher stiffness of composite column specimens that make the displacements small concerning applied load (increase in moment of inertial and equivalent of modulus of elasticity) because of composite action. When the load increases, the deformation becomes high and the slope of the curve becomes toward the horizontal direction due to decreased column stiffness up to ultimate loads. The inflection point becomes high when the steel fiber percentage increases and presences of CFRP that means there is enhancement in ductility in the range of elastic deformation (elastic load). The relationships between applied loads and displacements are 52%, 63%, 67% and 72% from the ultimate loads that represent the inflections points for all columns are approximately linear and then after that become nonlinear for columns C0%, C1%, C1.5% and C2% respectively. The presence of CFRP that surrounded all specimens makes the concrete more confinements that help and work such as tie reinforcement so that the amounts of lateral displacements become less. No slip developed between the interface of CFRP and concrete at the interfaces between these two materials due to the amount of epoxy more than enough to work as full interaction. The strengthening technique (CFRP distributions along with the height of the specimen) that adopted gave and

TABLE 12. Maximum axial and lateral displacements of composite columns

Column mark	Ultimate load (kN)	Maximum longitudinal displacement (mm)	Maximum lateral displacement (mm)	% load capacity	% Decrease of longitudinal displacement	% Decrease of lateral displacement
C0%	670	7.2	1.2	-	-	-
C1%	710	6.8	1.1	5.97	5.55	8.33
C1.5%	760	5.8	0.99	13.43	19.44	17.50
C2%	810	5.2	0.94	20.9	27.77	21.67



Figure 3. Mode of failure for all specimens

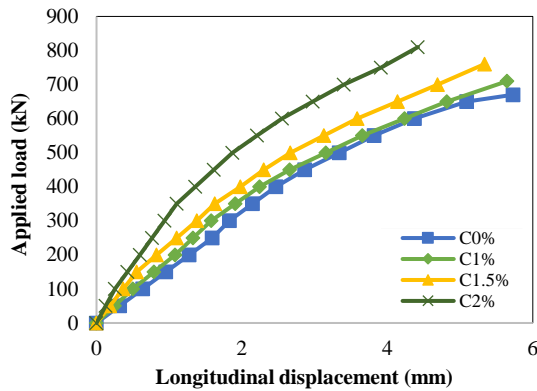

Figure 4. load-longitudinal displacement for all columns

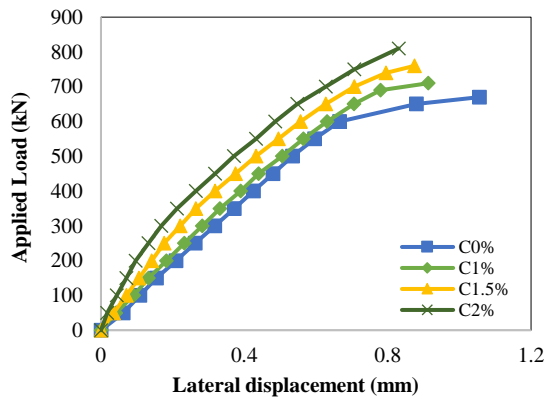

Figure 5. load- lateral displacement for all columns

provides significant concrete confinement due to an increase in strength column capacity. Project the ultimate load of 0% steel fiber on all other specimens gave less longitudinal and lateral displacement.

11. COLUMNS STRENGTH CAPACITY – ACI-440-2R-2002

Based on the ACI-318-2014 [18] as reinforced concrete column and ACI-440-2R-2002 [14] equations as compression members strengthening by FRP strips by the CFRP properties mentioned above, Table 13 lists the columns strength capacities and the comparisons between theoretical and experimental works. An increase in column capacity and reduction in longitudinal and lateral displacement rely on the increase in steel fiber percentage.

12. COLUMNS MODELING - FINITE ELEMENT ANALYSIS

Finite element analysis was performed in ANSYS software to simulate all column specimens that were strengthened by CFRP. Different elements are adopted for this purpose such as SOLID65 element for concrete material, LINK180 element for main reinforcement and stirrups, SHELL181 element to simulate CFRP layer [25]. The main assumptions considered in the numerical analysis were the plane section remains plane before and after applied loads, the concrete is homogeneous, full bounds between concrete and reinforcements, full interactions between the concrete and CFRP layers and the material nonlinearity of CFRP is linear up to failure. The support conditions and the applied loading were the same as experimental tests. Dimensions and mechanical properties that were adopted in numerical analysis to checkouts the performance of the tested specimens were the same as the experimental tests. Figure 6 shows the three-dimensional model of the element, main reinforcements and stirrups, and CFRP layers simulations/ column model meshes. Figures 7 to 14 show the longitudinal and

TABLE 13. Compressions between experimental and theoretical columns strength capacities

Column mark	Ultimate load (experimental test) (kN)	ACI-318-2014 [18] without CFRP	% Increase in capacity compare RC column (415 kN)	% Increase in capacity compare with ACI-318-2014 [18] Without CFRP	ACI-440-2R-2002 [14]	(Experimental/Theoretical) capacity	% Difference in capacity
RC Column	-	415	-	-	-	-	-
C0%	670	415	61.45	61.45	500	1.34	34
C1%	710	456	71.08	55.70	550	1.29	29
C1.5%	760	481	83.13	58.00	575	1.32	32
C2%	810	515	95.18	57.28	602	1.34	34

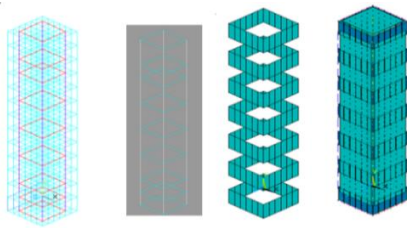

Figure 6. Three-dimensional wireframe model, main and stirrups reinforcements, CFRP layers and the full model

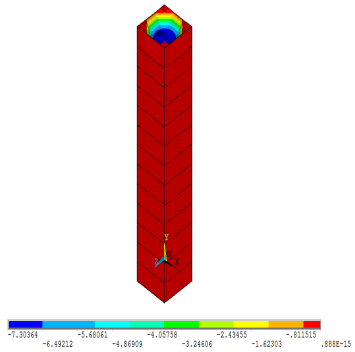

Figure 7. Longitudinal displacements along the C0% column model (mm)

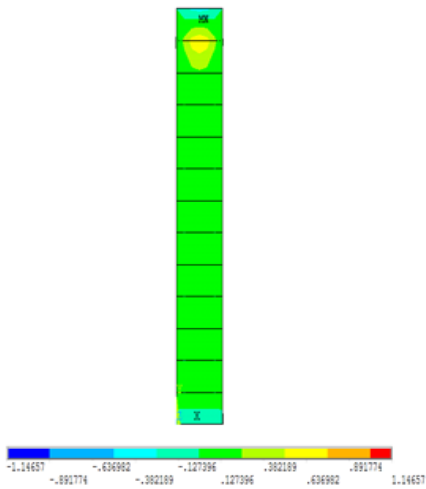

Figure 8. Lateral displacements along the C0% column model (mm)

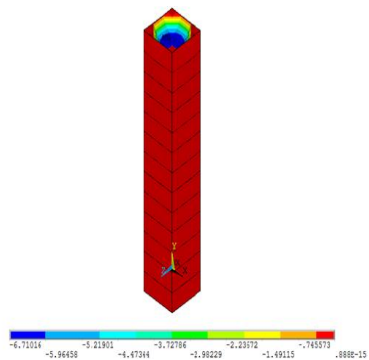

Figure 9. Longitudinal displacements along the C1% column model (mm)

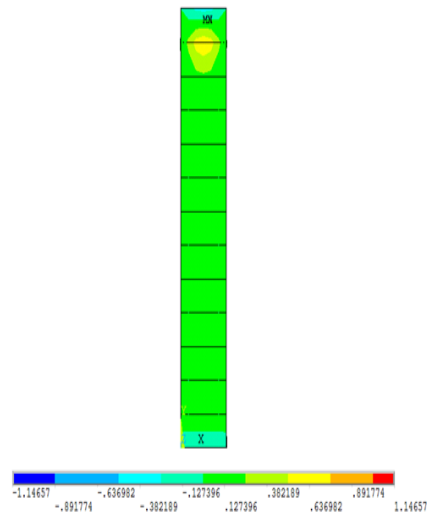

Figure 10. Lateral displacements along the C1% column model (mm)

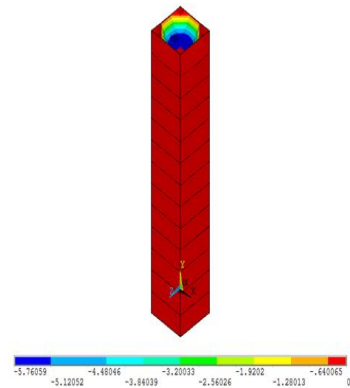

Figure 11. Longitudinal displacements along the C1.5% column model (mm)

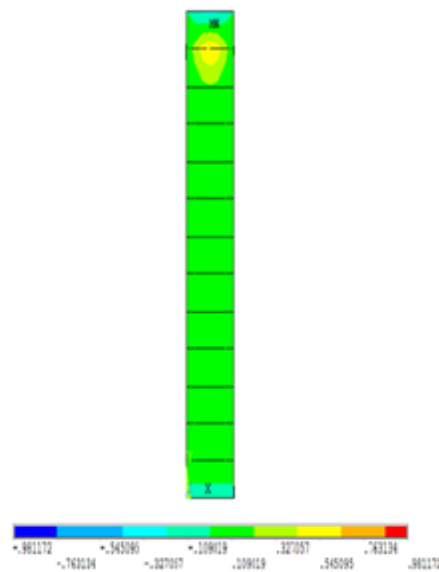

Figure 12. Lateral displacements along the C1.5% column model (mm)

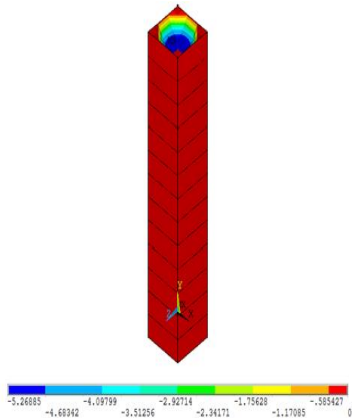

Figure 13. Longitudinal displacements along the C2% column model (mm)

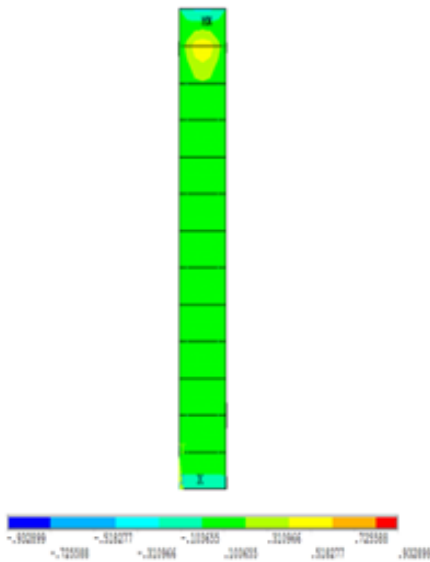

Figure 14. Lateral displacements along the C2% column model (mm)

lateral displacements numerical results for all the models. Table 14 lists comparison between experimental and numerical results. Figures 15 and 16 show the comparison results between experimental and numerical analysis with 45° line for longitudinal and lateral displacement. All the points lie rounded the 45° line, which means that the numerical solution is conservative. The meaning of the comparison results is rounded to unity and the standard deviation value along with the variance are found were very so small.

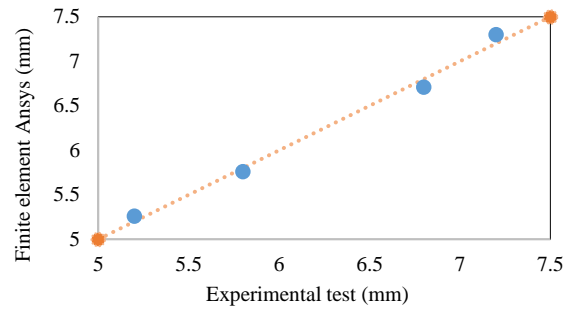

Figure 15. Comparison between finite element analysis and experimental test results for longitudinal displacements

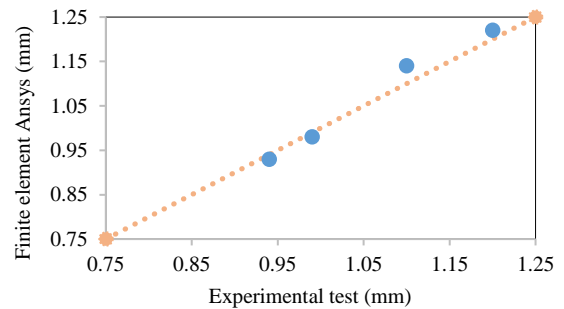

Figure 16. Comparison between finite element analysis and experimental test results for lateral displacements

TABLE 14. Compressions between experimental tests with columns simulated by ANSYS

Column mark	Maximum longitudinal displacement experimental (mm)	Maximum lateral displacement experimental (mm)	Maximum longitudinal displacement ANSYS (mm)	Maximum lateral displacement ANSYS (mm)	%longitudinal displacement ANSYS/experimental	%lateral displacement ANSYS/experimental
C0%	7.2	1.2	7.30	1.22	101.01	101.66
C1%	6.8	1.1	6.71	1.14	98.67	103.63
C1.5%	5.8	0.99	5.76	0.98	99.31	99.98
C2%	5.2	0.94	5.26	0.93	101.15	98.93
Mean					1.0004	1.0105
Standard division					0.0123	0.0205
Variance					0.000153	0.00042

13. CONCLUSION

Based on the experimental investigations, evaluations of the behavior and strength of SFSCC short composite columns subjected to static axial loads are examined. The following are the most important notices for observing and recording results:

1. Increase in SFSCC mechanical properties due to a reduction in the voids between concrete mixes.
2. Presences of steel fibers within the concrete mix increase the column capacity.
3. Increase in steel fibers ratio that reduces longitudinal and lateral displacement
4. Delay on the first crack loads on steel fiber concrete due to improvement in elastic displacement within the elastic zone of column specimens.
5. The wrapped CFRP around the concrete columns increases the concrete strength and resistance due to concrete confinements that reflect an increase in concrete compressive strength.
6. The column capacity as compared with the column capacity based on ACI-code, is increased due to the presence of steel fibers and CFRP strips.
7. Enhancement for strength and ductility due to composite action of composite columns that increases the stiffness due to increment in the moment of inertia and transform modulus of elasticity. In practice as experimental tests, the full composite action between CFRP and concrete column gave an increase in column strength and resistance to applied load.
8. The experimental strength capacity for each column is more than the theoretical analysis calculations that gave more safety in design, and there is an increase in column capacity as well as compared with the RC column only without strengthening.
9. Numerical results for all models by ANSYS showed close matching results with the experimental tests.
10. More specimens need to gate more information by taking more parameters such as CFRP later and layouts, type of loading such as biaxial loadings.

14. REFERENCES

1. Kazemi, M. T., Zakeri, I., and Shahvari, F. V., "Mixed Mode Fracture in Reinforced Concrete with Low Volume Fraction of Steel Fibers", *International Journal of Engineering, Transactions B: Applications*, Vol. 24, No. 1, (2011), 1–18. Retrieved from http://www.ije.ir/article_71877.html
2. Abdel-Hay, A. S., "Partial strengthening of R.C square columns using CFRP", *HBRC Journal*, Vol. 10, No. 3, (2014), 279–286. doi:10.1016/j.hbrj.2014.01.001
3. Karbhari, V., and Eckel, D., "Effects of Short-Term Environmental Exposure on Axial Strengthening Capacity of Composite Jacketed Concrete", *Journal of Composites Technology and Research*, Vol. 17, No. 2, (1995), 99-106. doi:10.1520/CTR10472J
4. Mirmiran, A., Yuan, W., and Chen, X., "Design for slenderness in concrete columns internally reinforced with fiber-reinforced polymer bars", *Structural Journal*, Vol. 98, No. 1, (2001), 116–125. Retrieved from <https://trid.trb.org/view/676209>
5. Bogdanovic, A. N. D. I., Strengthening Circular Concrete Columns Using FRP Sheets-Applications, Thesis, Composite Materials in Civil Engineering, University of Manitoba, Canada, (2002). Retrieved from https://scholar.google.com/scholar?hl=en&as_sdt=0%2C5&q=Strenghening+circular+concrete+columns+using+FRP+sheets-applications&btnG=
6. Olivova, K., and Bilcik, J., "Strengthening of concrete columns with CFRP", *Slovak Journal of Civil Engineering*, Vol. 1, (2009), 1–9. Retrieved from <https://www.researchgate.net/publication/303248946>
7. Ou, Y. C., and Truong, A. N., "Cyclic behavior of reinforced concrete L- and T-columns retrofitted from rectangular columns", *Engineering Structures*, Vol. 177, (2018), 147–159. doi:10.1016/j.engstruct.2018.09.012
8. Abdel-Mooty, M. A. N., Issa, M. E., Farag, H. M., and Bitar, M. A., "Seismic upgrading of square and rectangular RC columns using FRP wrapping", *WIT Transactions on The Built Environment*, Vol. 85, (2006), 1–10. doi:10.2495/HPSM06041
9. Ghosh, K. K., and Sheikh, S. A., "Seismic Upgrade with Carbon Fiber-Reinforced Polymer of Columns Containing Lap-Spliced Reinforcing Bars", *ACI Structural Journal*, Vol. 104, No. 2, (2007), 227–236. <https://doi.org/10.14359/18535>
10. Ali, I. F., Abdulridha, A. A., and Abbas, S. A., "Behavior and strength properties of steel fiber reinforced self-compacting concrete columns", *Journal of Engineering Science and Technology*, Vol. 15, No. 5, (2020), 3204–3217. Retrieved from http://jestec.taylors.edu.my/Vol%2015%20issue%205%20October%202020/15_5_25.pdf
11. Ozturk, B., Senturk, T., and Yilmaz, C., "Analytical investigation of effect of retrofit application using CFRP on seismic behavior of a monumental building at historical Cappadocia region of Turkey", In Proceedings of the 9th U.S. National and 10th Canadian Conference on Earthquake Engineering, Toronto, Canada, (2010). Retrieved from https://www.researchgate.net/publication/282186105_
12. Ozturk, B., Yilmaz, C., and Senturk, T., "Effect of FRP retrofit application on seismic behavior of a historical building at Nigde, Turkey", In Proceedings of the 14th European Conference on Earthquake Engineering, Ohrid, (2010). Retrieved from https://www.researchgate.net/publication/282186102_
13. Kianoush, M. R., and Esfahani, M. R., "Axial Compressive Strength of Reinforced Concrete Columns Wrapped with Fiber Reinforced Polymers (FRP)", *International Journal of Engineering, Transactions B: Applications*, Vol. 18, No. 1, (2005), 9–19. Retrieved from http://www.ije.ir/article_71563.html
14. American Concrete Institute, Guide for the design and construction of externally bonded FRP systems for strengthening concrete structures. Reported by ACI Committee 440.440.2R-02, (2002).
15. Iraqi Standard Specification IQS, Ordinary Portland cement. No. 5, Iraq, (1984).
16. Iraqi Standard Specification IQS, Natural aggregate using in concrete and building. No. 45, Iraq, (1984)
17. American Society of Testing and Materials ASTM C494M–17, Standard specification for chemical admixtures for concrete, (2005).
18. American Concrete Institute ACI 318, Building code requirements for concrete and commentary. Farmington Hills, MI 48331, USA, 503, (2014).

19. American Society of Testing and Materials ASTM-A996M, Standard specification for rail-steel and axle-steel deformed bars for concrete reinforcement, (2005).
20. European Federation for Specialist Construction Chemicals and Concrete Systems EFNARC, Specification and guidelines for self-compacting concrete, (2002).
21. American Concrete Institute ACI 237R-07, Self-consolidating concrete, (2007).
22. British Standard Institution BS .1881, Part 116, Method for determination of compressive strength of concrete cubes, (1989).
23. American Society of Testing and Materials ASTM C496-96, Standard test method for splitting tensile of cylindrical concrete specimens. Book of Standards, Vol. 04-02, (1996).
24. American Society of Testing and Materials ASTM C78M – 16, Standard test method for flexural strength of concrete (using simple beam with third-point loading), (2002).
25. ANSYS manual reference help Version 18.2, ANSYS Multiphasic, ANSYS, Inc. is a UL registered ISO 9001:2000 Company.

Persian Abstract

چکیده

ظرفیت مقاومت ستون‌های بتن آرمه برای مقاومت در برابر بارهای خارجی و انتقال آن‌ها بسیار مهم است. برای معماران، الزامات موتور برای استفاده از مقطع کوچک ستون‌های بتن مسلح یا در صورت عدم کنترل کیفیت، ما باید مقاومت فشاری بتن را افزایش دهیم یا از تکنیک تقویت عناصر سازه‌ای مانند ستون استفاده کنیم. در مقاله حاضر، رفتار و مقاومت چهار ستون بتونی خود متراکم تقویت شده با الیاف فولادی تقویت شده توسط یک لایه CFRP که به دور یک مربع از ستون‌های بتن مسلح تحت بارهای استاتیکی قرار گرفته است، بررسی شده است. بتن خود متراکم با استفاده از پودر سنگ آهک اتخاذ می‌شود و با درصد‌های مختلف فیبر فولاد مانند ۱٪، ۱/۵٪ و ۲٪ مخلوط می‌شود. آزمون‌های مختلفی برای بررسی خصوصیات مکانیکی بتن خود متراکم مخلوط با درصد فیبرهای مختلف فولاد انجام شده است. نتایج آزمایش نشان می‌دهد که در خصوصیات مکانیکی بتن مانند مقاومت فشاری، مقاومت کششی تقسیم شده و مدول پارگی افزایش یافته است که منعکس‌کننده افزایش ظرفیت بار ستون است. نمونه‌ها هنگامی که توسط CFRP بسته‌بندی می‌شوند. افزایش ظرفیت مقاومت ستون‌ها در مقایسه با ستون کنترل بیش از ۵۰٪ است. تمام نمونه‌های آزمایش با استفاده از تجزیه و تحلیل عناصر محدود توسط ANSYS مدل‌سازی شده و نتایج عددی با نمونه‌های آزمایش شده مقایسه می‌شود.
