RESEARCH NOTE

AN ADAPTIVE NONLINEAR CONTROLLER FOR SPEED SENSORLESS PMSM TAKING THE IRON LOSS RESISTANCE INTO ACCOUNT

*J. Soltani**

*Faculty of Engineering, Islamic Azad University, Khomeinishahr Branch
84175, Khomeinishahr, Iran
soltani@um.edu.my*

N. R. Abjadi and M. Pahlavaninezhad

*Faculty of Electrical and Computer Engineering, Isfahan University of Technology
84154, Isfahan, Iran
navidabjadi@yahoo.com – mnh_p@yahoo.com*

*Corresponding Author

(Received: October 19, 2006 – Accepted in Revised Form: January 30, 2008)

Abstract In this paper, an adaptive nonlinear controller is designed for rotor Surface Permanent Magnet Synchronous Motor (SPMSM) drive on the basis of Input-Output Feedback Control (IOFC), and Recursive Least Square (RLS) method. The RLS estimator detects the motor electromechanical parameters, including the motor iron loss resistance online. Moreover, a Sliding-Mode (SM) observer is developed for online estimation of the rotor speed and rotor position. In this control scheme, the torque reference signal is generated by a conventional speed PI controller. The effectiveness and feasibility of the proposed control approach is tested by simulation. Computer simulation results show that the errors in the estimated quantities asymptotically converge to zero. These results also show that the drive system is stable and robust against the parameter uncertainties and external load torque disturbance.

Keywords Surface Permanent Magnet Synchronous Motor (SPMSM), Input-Output Feedback Control (IOFC), Recursive Least Square (RLS), Sliding-Mode (SM)

چکیده در این مقاله، یک کنترل کننده غیرخطی تطبیقی برای موتور سنکرون مغناطیس دائم نوع سطحی (SPMSM) بر پایه کنترل پسخورده ورودی - خروجی (IOFC) و روش حداقل مربعات بازگشتی (RLS) طراحی می شود. تخمین گر RLS بصورت روی خط پارامترهای الکترومکانیکی شامل مقاومت تلفات آهن موتور را تخمین می زند. علاوه بر این، یک مشاهده گر مد - لغزشی (SM) برای تخمین روی خط سرعت و موقعیت روتور ارائه می شود. در این طرح کنترلی، سیگنال مرجع گشتاور بوسیله یک کنترل کننده PI معمولی ایجاد می شود. موثر و عملی بودن روش کنترل پیشنهادی با شبیه سازی کامپیوتری بررسی می شود. نتایج شبیه سازی کامپیوتری نشان می دهد که خطای کمیت های تخمین زده شده بطور مجانبی به صفر همگرا می شود. همچنین این نتایج نشان می دهند که سیستم درایو پایدار و نسبت به نامعینی های پارامتری و اغتشاش گشتاور بار بیرونی مقاوم است.

1. INTRODUCTION

In recent years, because of the advancements achieved in magnetic materials, semiconductor power devices and nonlinear control theories, the

PMSM drive plays a vital role in motion control applications between low to medium power ranges [1]. In the traditional field orientation method [2], it is widely adopted to linearize the nonlinear model and has obtained significant achievement.

However, for higher performance requirements, such as robots and machine tools, this method may not be sufficient during speed transient. Over the last 20 years, the state feedback linearization and IOF linearization have been applied to induction and PMSM drives [3-5]. The basic idea is to first transforming the motor nonlinear system equations into linear ones through nonlinear feedback, and then using the well-known linear design techniques to complete the controller design. These techniques however require a full knowledge of motor parameters and load conditions with sufficient accuracy.

In [6], a nonlinear controller is described for a SPMSM using the IOF linearization. In this control scheme, an integral control method is introduced to improve the motor drive robustness against the inaccurate speed measurement. However, in this system the variations of other motor parameters are not considered. In [7,8] adaptive IOF linearization techniques are described for the speed control of the PMSM. Although according to these methods a good performance can be obtained, the controller designs are quite complex. In addition, according to these controllers, the drive system is not robust to all parameter uncertainties. In [9], a nonlinear adaptive speed controller approach is presented for SPMSM based on adaptive backstepping. In this control scheme, only the uncertainties in the stator resistance and friction coefficient and load torque disturbance are considered.

To the authors' knowledge, the nonlinear control methods applied so far for PMSM drives, have not taken into account the motor iron loss. In PM machines, iron loss forms a significant fraction of total loss partly due to the non sinusoidal flux density distribution. Despite the number of papers that deal with online identification of the iron loss resistance for induction motor drives, there is little attention paid to identification of iron loss resistance of PMSM drives [10].

Using the SPMSM iron loss model described in [10,11], the main aim of this paper is to introduce a new controller for speed sensorless of the SPMSM drive. The adaptive nonlinear controller is designed on the basis of IOF linearization and the RLS method. The RLS method is a simple and strong estimation

technique [12]. The RLS estimator is developed for online detecting motor electromechanical parameters including the iron loss resistance, using the motor measured currents and voltages. The RLS estimator operates in parallel with IOF controller and a SM observer that estimates the rotor speed and rotor position online. Based on the Lyapunov's stability theory, the SM observer is developed by taking the motor iron loss into account. This paper is organized as follows. In Section 2 the SPMSM model is described. The IOF linearizing controller is presented in Section 3. In Section 4, RLS estimator is discussed. The SM observer is developed in Section 5 and system simulation is shown in Section 6. Finally, the paper is concluded in Section 7.

2. SPMSM MODEL

The d and q axis equivalent circuits of SPMSM drive are shown in Figure 1. In these circuits the iron loss resistance is taken into account. From Figure 1, the SPMSM mathematical model is obtained as

$$\begin{aligned} \frac{d i_{dm}}{dt} = & -\frac{R}{K} i_{dm} + P i_{qm} \omega_r + \frac{1}{K} v_d \frac{d i_{qm}}{dt} = \\ & -\frac{R}{K} i_{qm} - P i_{dm} \omega_r - \frac{P K \phi}{K} \omega_r + \frac{1}{K} v_q \end{aligned} \quad (1)$$

$$\begin{aligned} \frac{d \omega_r}{dt} = & \frac{3P\phi}{2J} i_{qm} - \frac{B}{J} \omega_r - \frac{T_L}{J} \\ \frac{d\theta}{dt} = & \omega_r \end{aligned} \quad (2)$$

Where R , B , J , P and T_L are stator resistance, friction coefficient, momentum of inertia, number of pole pairs and load torque. Also K and K_ϕ are defined by

$$K = \left(1 + \frac{R}{R_i}\right)L, \quad K_\phi = \left(1 + \frac{R}{R_i}\right)\phi$$

Where R_i , ϕ and L are respectively the motor iron loss resistance, rotor permanent magnet flux, and stator inductance.

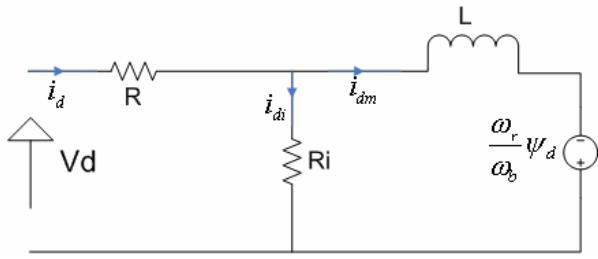

(a)

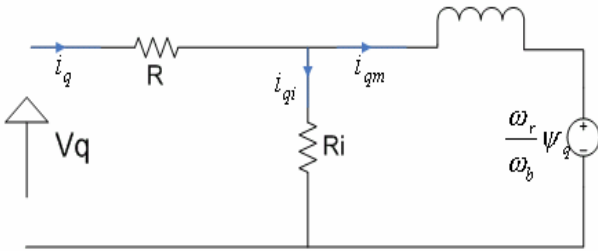

(b)

Figure 1. D and q axis equivalent circuits of SPMSM.

3. INPUT-OUTPUT FEEDBACK CONTROLLER

According to the nonlinear model of SPMSM, the linear control methods are not applicable for wide range operation of SPMSM. The input-output feedback linearization method (IOFC) is one of the effective nonlinear control methods that can be used to control nonlinear plants such as SPMSM.

The IOFC scheme is applied to SPMSM in the following way [4].

Assume that

$$y_1 = i_{dm}, \quad y_2 = i_{qm} \quad (3)$$

Thus from (1) the system output dynamics are

$$\begin{aligned} \dot{y}_1 &= \frac{di_{dm}}{dt} = -\frac{R}{K}i_{dm} + P i_{qm} \omega_r + \frac{1}{K}v_d \\ \dot{y}_2 &= \frac{di_{qm}}{dt} = -\frac{R}{K}i_{qm} - P i_{dm} \omega_r - \frac{PK\phi}{K}\omega_r + \frac{1}{K}v_q \end{aligned} \quad (4)$$

Considering the IOF linearizing technique, the new control inputs are defined by:

$$\begin{aligned} v_d &= \frac{di_{dmref}}{dt} - \alpha_1 e_d = \dot{y}_1 \\ v_q &= \frac{di_{qmref}}{dt} - \alpha_2 e_q = \dot{y}_2 \end{aligned} \quad (5)$$

Linking (3) and (5), the error dynamics are

$$\dot{e}_d = -\alpha_1 e_d, \quad \dot{e}_q = -\alpha_2 e_q \quad (6)$$

With

$$e_d = i_{dm} - i_{dmref}, \quad e_q = i_{qm} - i_{qmref}$$

Where subscript “ref” denotes the reference value.

From (6), it is seen that the magnetizing currents converge exponentially to zero. Notice that the above IOF linearizing system has an order of zero dynamic and in [4], it has been proven that this zero dynamic is input to a state stable.

4. RECURSIVE LEAST SQUARES METHOD

The recursive least square (RLS) algorithm is well-known as a simple and strong estimation technique [12]. This method can only be applied to the models defined by

$$y(t) = \varphi^T(t)\theta \quad (7)$$

Where y is an observed variable. θ is the vector of constant or slowly variable parameters to be determined and φ is a vector of known functions that may depend on other known variables [12].

Applying the RLS method to the model of (7), the vector θ is estimated in the following way

$$\begin{aligned} \hat{\theta}(t) &= \hat{\theta}(t-1) + K(t)(y(t) - \varphi^T(t)\hat{\theta}(t-1)) \\ K(t) &= P(t-1)\varphi(t)(\lambda I + \varphi^T(t)P(t-1)\varphi(t))^{-1} \\ P(t) &= (I - K(t)\varphi^T(t))P(t-1)/\lambda \end{aligned} \quad (8)$$

Where $0 < \lambda \leq 1$ and called the forgetting factor.

From Figure 1b, the q axis voltage equation of SPMSM can be obtained as

$$Kp i_q = -R i_q - K P \omega_r i_d - P \phi \omega_r + v_q + \frac{L}{R_i} p v_q + \frac{L}{R_i} P \omega_r v_d \quad (9)$$

Where

$$p = \frac{d}{dt}$$

Multiplying both sides of (9) by $\frac{1}{p+a}$, equation (9) becomes

$$K \frac{p}{p+a} i_q = -R \frac{1}{p+a} i_q - K \frac{1}{p+a} (P \omega_r i_d) - \phi \frac{1}{p+a} P \omega_r + \frac{1}{p+a} v_q + \frac{L}{R_i} \frac{p}{p+a} v_q + \frac{L}{R_i} \frac{1}{p+a} (P \omega_r v_d) \quad (10)$$

Assume that:

$$i_{qf} = \frac{1}{p+a} i_q, \quad v_{df} = \frac{1}{p+a} v_d, \quad \omega_{rf} = \frac{1}{p+a} \omega_r \quad (11)$$

$$\omega_{idf} = \frac{1}{p+a} \omega_r i_d, \quad \omega_{vdf} = \frac{1}{p+a} \omega_r v_d$$

Then

$$\frac{p}{p+a} i_q = i_q - a i_{qf}, \quad \frac{p}{p+a} v_q = v_q - a v_{qf} \quad (12)$$

Combining (10), (11) and (12), yields

$$v_{qf} = K(i_q - a i_{qf} + P \omega_{idf}) + R i_{qf} + \phi P \omega_{rf} - \frac{L}{R_i} (v_q - a v_{qf} + P \omega_{vdf}) \quad (13)$$

Similarly the mechanical equation is rewritten as

$$J \frac{d\omega_r}{dt} = \frac{3P\phi}{2} (i_q (1 + \frac{R}{R_i}) - \frac{v_q}{R_i}) - B \omega_r - T_L \quad (14)$$

Multiplying both sides of (14) by $\frac{1}{p+b}$, yields

$$v_{qf} = \frac{-2J}{3P\phi} (\omega_r - b \omega_{rf}) + (R_i + R) i_{qf} - \frac{2B R_i}{3P\phi} \omega_{rf} - \frac{2R_i T_L}{3P\phi} \quad (15)$$

Comparing (13) and (15) with (7), results in

$$y = \begin{bmatrix} v_{qf} \\ v_{qf} \end{bmatrix}, \quad \phi^T = \begin{bmatrix} \phi_1^T & 0 \\ 0 & \phi_2^T \end{bmatrix}$$

$$\theta = \begin{bmatrix} K & R & \phi & \frac{L}{R_i} \\ -\frac{2J}{3P\phi} & R_i + R & -\frac{2B R_i}{3P\phi} & -\frac{2R_i T_L}{3P\phi} \end{bmatrix}^T \quad (16)$$

Where

$$\phi_1^T = [i_q - a i_{qf} + P \omega_{idf} \quad i_{qf} \quad P \omega_{rf} - (v_q - a v_{qf} + P \omega_{vdf})]$$

$$\phi_2^T = [\omega_r - b \omega_{rf} \quad i_{qf} \quad \omega_{rf} \quad 1]$$

5. SLIDING-MODE OBSERVER

Using Equations 1 and 2, the SPMSM model in the fixed (α - β) axis reference frame, can be derived as:

$$\frac{di_{\alpha m}}{dt} = -\frac{R}{K} i_{\alpha m} + P \frac{K\phi}{K} \omega_r \sin P\theta_r + \frac{1}{K} v_\alpha$$

$$\frac{di_{\beta m}}{dt} = -\frac{R}{K} i_{\beta m} - P \frac{K\phi}{K} \omega_r \cos P\theta_r + \frac{1}{K} v_\beta$$

$$\frac{d\omega_r}{dt} = \frac{3P\phi}{2J} (i_{\beta m} \cos P\theta_r - i_{\alpha m} \sin P\theta_r) - \frac{B}{J} \omega_r - \frac{T_L}{J}$$

$$\frac{d\theta_r}{dt} = \omega_r \quad (17)$$

Dividing the SPMSM drive system states respectively by measured and estimated states

which are respectively defined by $(i_{am}, i_{\beta m})$ and (θ_r, ω_r) , the system state dynamics become [13,14]

$$\begin{aligned}\dot{x}_1 &= f_1(x, u) \\ \dot{x}_2 &= f_2(x, u)\end{aligned}\quad (18)$$

Where

$$x = [x_1 \ x_2]^T, \quad x_1 = [i_{am} \ i_{\beta m}]^T, \quad x_2 = [\omega_r \ \theta_r]^T \quad \text{and} \\ u = [v_\alpha \ v_\beta]^T.$$

From (18), the system estimated dynamic is described by

$$\begin{aligned}\dot{\hat{x}}_1 &= f_1(\hat{x}, u) \\ \dot{\hat{x}}_2 &= f_2(\hat{x}, u)\end{aligned}\quad (19)$$

Where (^) means the estimated value of each state and each parameter.

Assume the following SM-observer:

$$\begin{aligned}\dot{\hat{x}}_1 &= f_1(\hat{x}, u) - k_1 I_s \\ \dot{\hat{x}}_2 &= f_2(\hat{x}, u) - k_2 I_s\end{aligned}\quad (20)$$

Where K_1 and K_2 are the observer gain matrices and vector I_s is defined as

$$I_s = \left[\text{sgn}\left(\frac{s\alpha}{\varphi_1}\right), \text{sgn}\left(\frac{s\beta}{\varphi_2}\right) \right] \quad (21)$$

Where

$$s\alpha = \hat{i}_{am} - i_{am} = \tilde{i}_{am}$$

and

$$s\alpha = \hat{i}_{\beta m} - i_{\beta m} = \tilde{i}_{\beta m}.$$

From (18) and (19), the system error dynamic obtained as

$$\begin{aligned}\dot{\hat{x}}_1 &= f_1(\hat{x}, u) - f_1(x, u) \\ \dot{\hat{x}}_2 &= f_2(\hat{x}, u) - f_2(x, u)\end{aligned}\quad (22)$$

Define a Lyapunov function as follow:

$$V = \frac{1}{2} \frac{d}{dt} (s^T s) \quad (23)$$

The observer states convergence is ensured if

$$\dot{V} = s^T \dot{s} < 0.$$

Let the observer errors are chosen as

$$\begin{aligned}e_1 &= \hat{x}_1 - x_1 \\ e_2 &= \hat{x}_2 - x_2\end{aligned}\quad (24)$$

Substituting (22) into (24) gives

$$\begin{aligned}\dot{e}_1 &= \Delta f_1 - k_1 I_s \\ \dot{e}_2 &= \Delta f_2 - k_2 I_s\end{aligned}\quad (25)$$

Where

$$\Delta f_1 = f_1(\hat{x}, u) - f_1(x, u)$$

and

$$\Delta f_2 = f_2(\hat{x}, u) - f_2(x, u).$$

Approximate $f_1(x, u)$ and $f_2(x, u)$ with first terms of Taylor series, Δf_1 and Δf_2 become

$$\begin{aligned}\Delta f_1 &= F_{11} E_1 + F_{12} E_2 \\ \Delta f_2 &= F_{21} E_1 + F_{22} E_2\end{aligned}\quad (26)$$

Where from (17),

$$F_{11} = \frac{\partial f_1}{\partial x_1} = \begin{bmatrix} -\frac{R}{K} & 0 \\ 0 & -\frac{R}{K} \end{bmatrix}, \quad F_{22} = \frac{\partial f_2}{\partial x_2} = \begin{bmatrix} -\frac{B}{J} & \rho \\ 1 & 0 \end{bmatrix} \quad (27)$$

$$F_{12} = F_{21} = \frac{\partial f_1}{\partial x_2} =$$

$$\begin{bmatrix} P \frac{K_\varphi}{K} \sin P \theta_r & P \frac{K_\varphi}{K} \hat{\omega}_r \cos P \theta_r \\ -P \frac{K_\varphi}{K} \cos P \theta_r & P \frac{K_\varphi}{K} \hat{\omega}_r \sin P \theta_r \end{bmatrix} \quad (28)$$

With

$$\rho = \frac{3P\varphi}{2J} [-\hat{\omega}_r i_{am} \cos P \hat{\theta}_r - \hat{\omega}_r i_{\beta m} \sin P \hat{\theta}_r]$$

As the motor current errors ($\tilde{i}_\alpha, \tilde{i}_\beta$) tend asymptotically to zero, or in other words the sliding behavior occurs ($s = \dot{s} = 0$), then $e_2 = \dot{e}_2 = 0$.

Combining (25) and (26), yields

$$\dot{e}_2 = \Delta f_2 - k_2 k_1^{-1} \Delta f_1 \cong (F_{22} - k_2 k_1^{-1} F_{12}) e_2 \quad (29)$$

Equation 29 shows the system estimated errors (e_2) will exponentially decrease to zero with a time constant determined by $(F_{22} - k_2 k_1^{-1} F_{12})$.

In (29), the gain matrices k_1 and k_2 can be adjusted so that the eigenvalues of nonsingular matrix $(F_{22} - k_2 k_1^{-1} F_{12})$ become negative and as a result vector e_2 exponentially tends to zero.

Let the gain matrix k_1 is to be chosen as:

$$k_1 = \begin{bmatrix} b_s & 0 \\ 0 & b_s \end{bmatrix} \quad (30)$$

Where b_s is a positive constant that has to be selected.

Combining (25) with (26) and (27), using equation (29), yields

$$\dot{V} = s^T \dot{s} \cong e_1^T (F_{11} e_1 + F_{12} e_2 - k_1 I_s) e_1 \quad (31)$$

Substituting (27) in (31) for F_{11} and F_{22} one can conclude that if b_s is chosen upon following inequality,

$$b_s \geq \max \left\{ \frac{K\varphi}{K} (e_\omega \sin P \hat{\theta} + P \hat{\omega}_r e_\theta \cos P \hat{\theta}), \right. \\ \left. \frac{K\varphi}{K} (e_\omega \cos P \hat{\theta} + P \hat{\omega}_r e_\theta \sin P \hat{\theta}) \right\} \quad (32)$$

Then the sliding reaching condition is always satisfied, if the gain matrix k_2 is also chosen as:

$$k_2 k_1^{-1} = \begin{bmatrix} a_1 & 0 \\ 1 & a_2 \end{bmatrix} F_{12}^{-1} \quad (33)$$

Where a_1 and a_2 are assumed positive constants.

Linking (26) and (33) gives

$$\dot{e}_2 = F_{22} - \begin{bmatrix} a_1 & 0 \\ 0 & a_2 \end{bmatrix} = \begin{bmatrix} -\frac{B}{J} - a_1 & \rho \\ 0 & -a_2 \end{bmatrix} \quad (34)$$

The eigenvalues of the above matrix are obtained as

$$\lambda_\omega = -\frac{B}{J} - a_1, \quad \lambda_\theta = -a_2$$

The observer convergence rate is determined by adjusting a_1 and a_2 . Once positive constants b_s , a_1 and a_2 are set, the gain matrix k_2 corresponding to system estimated states is obtained from (33) as:

$$k_2 = b_s \begin{bmatrix} a_1 \frac{K}{K_\varphi} \sin P \hat{\theta}_r & -a_1 \frac{K}{K_\varphi} \cos P \hat{\theta}_r \\ \frac{K}{K_\varphi} \sin P \hat{\theta}_r & +a_2 \frac{K}{K_\varphi} \frac{\cos P \hat{\theta}_r}{P \hat{\omega}_r} \\ -\frac{K}{K_\varphi} \cos P \hat{\theta}_r & +a_2 \frac{K}{K_\varphi} \frac{\sin P \hat{\theta}_r}{P \hat{\omega}_r} \end{bmatrix} \quad (35)$$

Equation 35 shows the elements of matrices k_1 and k_2 depend on estimated states $\hat{x}_2 = [\hat{\omega}_r \hat{\theta}_r]$ and as a consequence they have to update at each computation step Δt of time.

Replacing gain matrices k_1 and k_2 from (30) and (35) into (20), the system estimated states $\hat{x} = [\hat{x}_1 \hat{x}_2]^T$ can be obtained by solving (20). From

(35), one can see that the term $\frac{1}{\hat{\omega}_r}$ will overflow numerically for very low speeds.

This problem can be solved if in the speed region $\hat{\omega}_r < 1$, the gain matrix k_2 is changed to

$$k_2 = b_s \begin{bmatrix} a_1 \frac{K}{K_\varphi} \sin P \hat{\theta}_r & -a_1 \frac{K}{K_\varphi} \cos P \hat{\theta}_r \\ \frac{K}{K_\varphi} \sin P \hat{\theta}_r & +a_2 \frac{K}{K_\varphi} P \hat{\omega}_r \cos P \hat{\theta}_r \\ -\frac{K}{K_\varphi} \cos P \hat{\theta}_r & +a_2 \frac{K}{K_\varphi} P \hat{\omega}_r \sin P \hat{\theta}_r \end{bmatrix} \quad (36)$$

It is not difficult to show the eigenvalues of matrix (36) are

$$\lambda_\omega = -\frac{B}{J} - a_1, \quad \lambda_\theta = -a_2 \omega_r^2$$

Which also guaranty that the SM-observer stability and convergence is still ensured.

load torque disturbance. These results also show that the SM observer asymptotically detects the desired speed reference command.

6. SYSTEM SIMULATION

The proposed control approach is implemented in an overall block diagram shown in Figure 2 Using the d-q axis equivalent circuits shown in Figure 1, a C++ computer program was developed for system modeling. A static fourth order Runge-Kutta method is used to solve the nonlinear equations. Simulation results are obtained for a SPMSM with the parameters shown in Table 1. These results are obtained for $R = 2R_n$, $L = 0.5L_n$, $\phi = 0.8\phi_n$, $R_i = 0.5R_{in}$, $J = 1.8J_n$, $B = 3B_n$ and the load torque and speed profiles respectively as shown in Figures 3c and 3d, where subscript 'n' denotes the nominal value. From simulated results given in Figure 3, one can see that the drive system performance is robust and stable against parameter variations and external

7. CONCLUSIONS

A robust nonlinear controller has been designed for speed sensorless SPMSM drives based on IOFC and RLS methods. The RLS estimator detects the motor electrical parameters including the motor iron loss resistance and motor load torque online. The estimated parameters are used by IOFC and a SM-observer that estimates the rotor speed and rotor position online. The proposed control approach is verified by computer simulation. The simulation results obtained show that the estimated parameters rapidly converge to their actual values and the drive system control is stable and robust subject to parameter variations and external load torque disturbance occurrences.

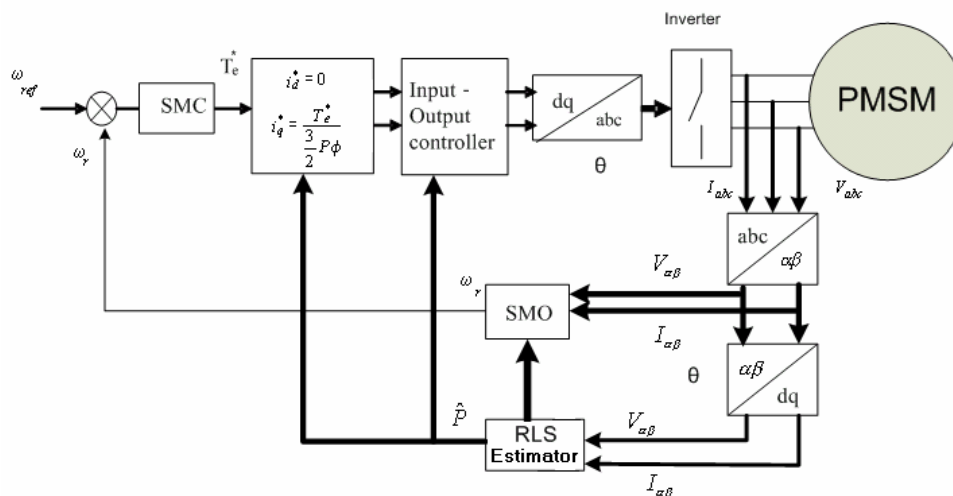
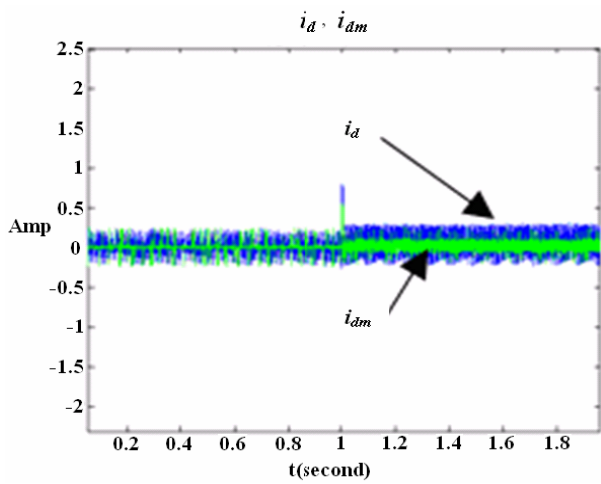

Figure 2. Block diagram of SPMSM drive system.

TABLE 1. Machine Parameters.

$P = 2$	$J_n = 0.0004 \text{ nms/rad}$	$J_n = 0.00617 \text{ kg m}^2$	$\phi_n = 0.5 \text{ wb}$
$R_n = 1.6 \Omega$	$L_n = 9.4 \text{ mH}$	$R_{in} = 50 \Omega$	



(a)

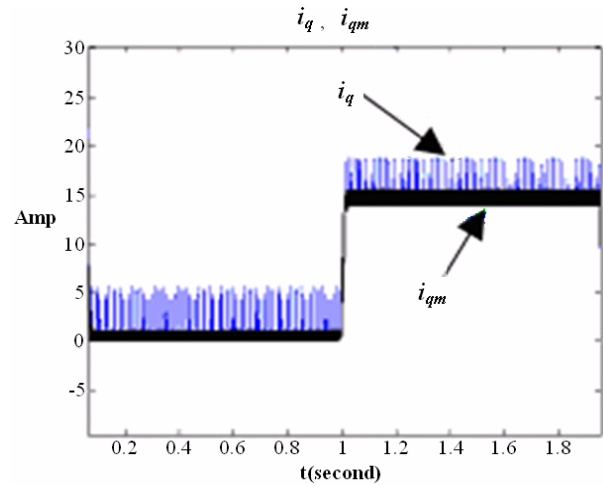

(b)

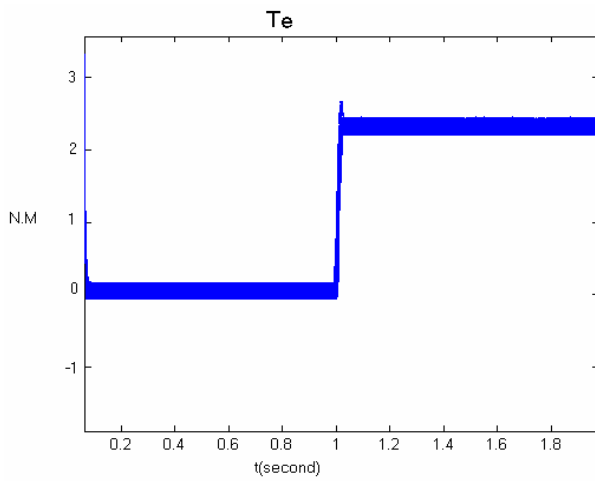

(c)

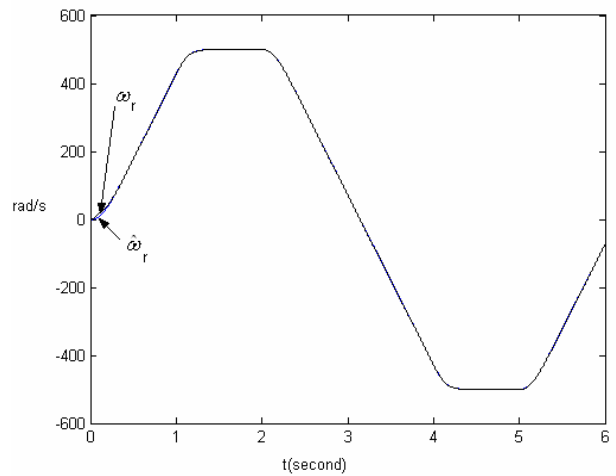

(d)

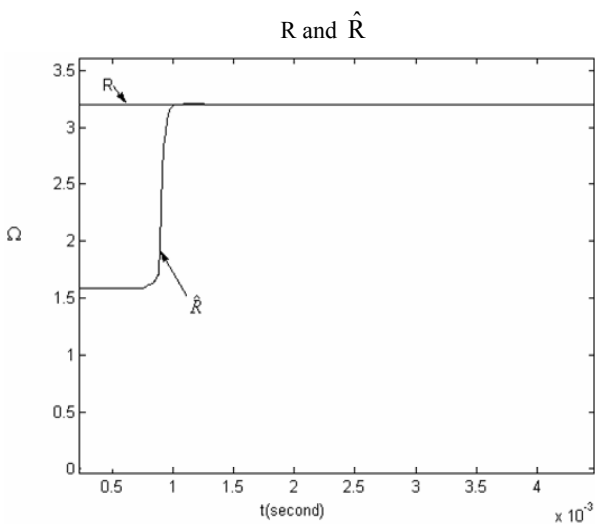

(e)

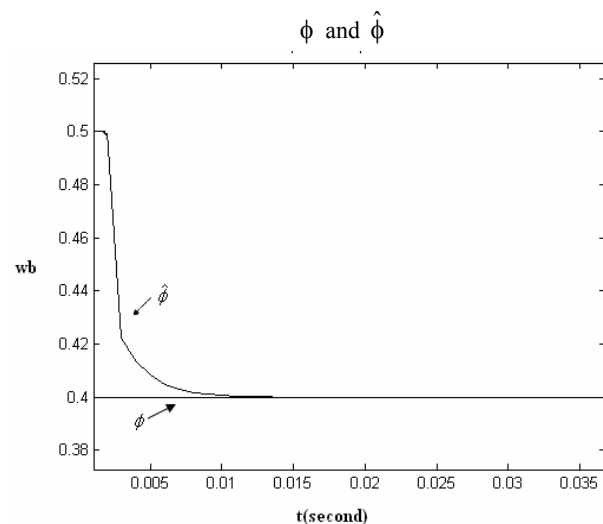

(f)

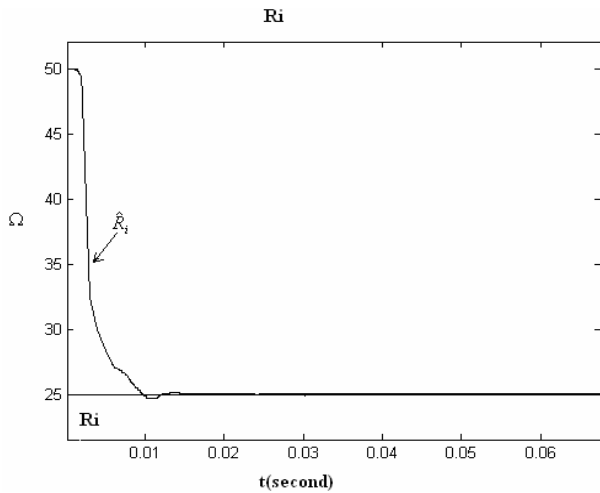

(g)

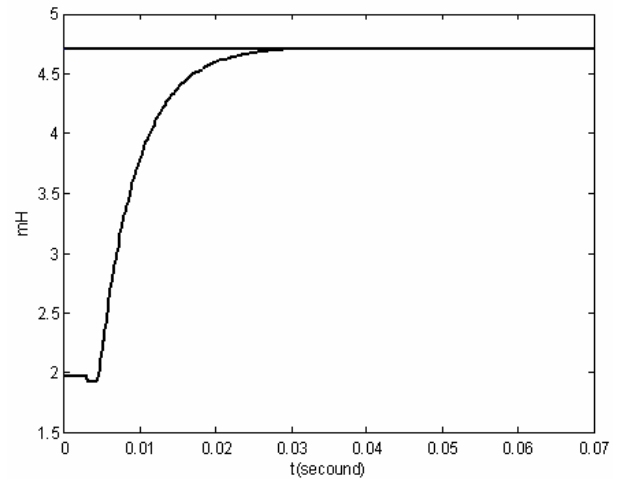

(h)

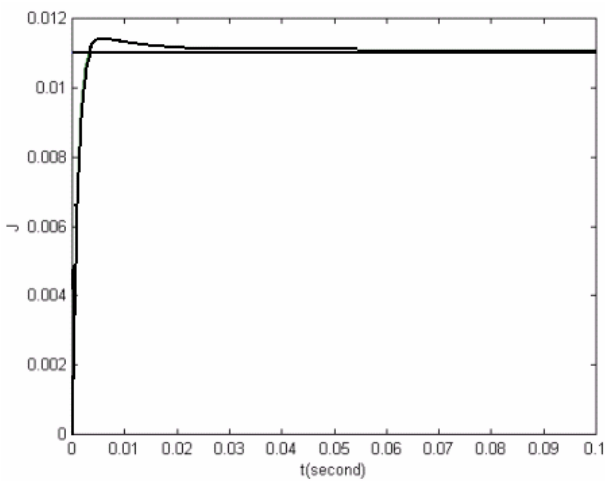

(i)

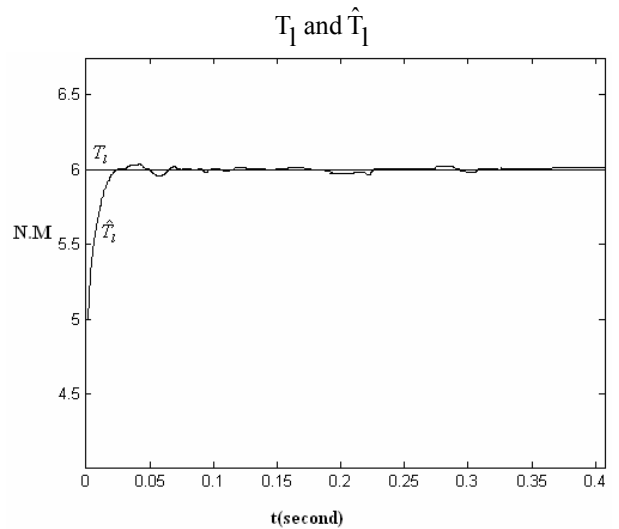

(j)

Figure 3. (a) Stator direct axis currents, (b), Stator q axis currents, (c) Motor torque, (d) Motor speed estimation (e) Stator resistance estimation, (f) Rotor magnetic flux estimation, (g) Motor iron loss resistance estimation (h) Inductance estimation, (i) Estimation of parameter J, (j) Motor load torque estimation.

8. REFERENCES

1. Rahman, M. A. and Zhou, P., "Accurate Determination of Permanent Magnet Motor Parameters by Digital Torque Angle Measurement", *Journal of Applied physics*, Vol. 76, No. 10, (1994), 6868-6870.
2. Noguchi, T., Kondo, S. and Takahashi, I., "Field-Oriented Control of an Induction Motor with Robust on-Line Tuning of its Parameters", *IEEE Trans. Ind. Appl.*, Vol. 33, (1977), 35-42.
3. Bodson, M., Chiasson, J. and Novatnak, R., "High Performance Induction Motor Control Via Input-Output Linearization", *IEEE Control System Magazine*, (1994), 25-33.
4. Amor, L. B., Dessaint, L. A., Ghribi, M. and Akhrif, O., "Adaptive Nonlinear Control of a Permanent Magnet Synchronous Motor", *International Conference on Industrial Electronics, Control and Instrumentation, IECON '94*, (September 5-9, 1994), 2110-2115.
5. Solsona, J., Valla, M. I. and Muravchik, C., "Nonlinear Control of Permanent Magnet Synchronous Motor with Disturbance Torque Estimation", *IEEE Trans on*

- Energy Conversion*, Vol. 15, No. 2, (June 2000), 163-168.
6. Le Pioufle, B., "Comparison of Speed Nonlinear Control Strategists for the Synchronous Servomotor", *Elect. Mach. Power Syst.*, Vol. 21, (1993), 151-169.
 7. Kim, K. H., Baik, I. C., Chung, S. K. and Young, M. J., "Robust Speed Control of Brushless DC Motor Using Adaptive Input-Output Linearization Technique", *Proc. IEEE Elec. Power Appl.*, Vol. 144, No. 6, (1997), 469-475.
 8. Hwakim, K. and Joong Youn, M., "A Nonlinear Speed Control for PM Synchronous Motor Using a Simple Disturbance Estimation Technique", *IEEE Trans. on Ind. Appl.*, Vol. 4, No. 1, (June 2002), 524-534.
 9. Zhou, J. and Wang, Y., "Adaptive Backstepping Speed Controller Design for a Permanent Magnet Synchronous Motor", *IEEE Proc. Elect. Power Appl.*, Vol. 149, No. 2, (March 2002), 165-172.
 10. Urasaki, N., Senjyu, T., and Uezato, K., "A Novel Calculation Method for Iron Loss Resistance Suitable in Modeling Permanent-Magnet Synchronous Motors", *IEEE Trans. on Energy Conv.*, Vol. 18, No. 1, (March 2003), 41-47.
 11. Urasaki, N., Senjyu, T. and Uezato, K., "Relationship of Parallel Model and Series Model for Permanent Magnet Synchronous Motors Taking Iron Loss Into Account", *IEEE Trans. on Energy Conv.*, Vol. 19, No. 2, (June 2004), 265-270.
 12. Astrom, K. J. and Wittenmark, B., "Adaptive Control", 2nd Ed., Addison-Wesley Longman Publishing Co., Boston, MA, U.S.A., (1995).
 13. Spooner, J. T., "Stable Adaptive Control and Estimation for Nonlinear Systems: Neural and Fuzzy Approximator Techniques", John Wiley and Sons Inc., New York, U.S.A., (May 2002).
 14. Changsheng, L. I., and Malik, E. L., "A Sliding Mode Observer for Sensorless Control of Permanent Magnet Synchronous Motors", *Ind. Appl. Conf. 2001 Thirsty Sixth IAS Annual Meeting*, Vol. 2, (September-October 2001), 1273-1278.